

Payload Bay Doors

and

Radiator Panels

Familiarization

Handbook

**ORIGINAL CONTAINS
COLOR ILLUSTRATIONS**

(NASA-TM-107793) PAYLOAD BAY DOORS AND
RADIATOR PANELS FAMILIARIZATION HANDBOOK
(NASA) 92 p

CSCL 22B

N92-20676

Unclass

G3/16 0078069



Prepared by:

John A. Godbold
TP-POD-2

PREFACE

The "Payload Bay Doors and Radiator Panels Familiarization Handbook" has been written to meet a requirement of NASA-KSC's Accelerated Training Program (ATP). The Payload Bay Doors and the Radiator Panels are basic elements of the Space Shuttle and those personnel directly associated with these systems should understand how they function. This document is intended to be a review of these systems for Payload Operations personnel; however, a much more diverse group can possibly benefit from this handbook.

TABLE OF CONTENTS

1.	INTRODUCTION.....	1
2.	PAYLOAD BAY DOORS (PLBDs).....	2
2.1	OVERALL STRUCTURE AND PERTINENT DETAILS.....	2
2.2	INTERNAL STRUCTURAL MEMBERS.....	3
2.2.1	Thin-walled Structural Elements.....	3
2.2.2	Shear Pins and Thermal Expansion.....	7
2.2.3	Ribs, Longerons, and Intercostals.....	9
2.2.4	Radiator Attach Points.....	11
2.2.4.1	Deployable Radiator Panels.....	11
2.2.4.2	Fixed Radiator Panels.....	14
2.3	DOOR LONGERON MECHANISMS.....	15
2.3.1	Hinges.....	15
2.3.1.1	Fixed Hinges.....	18
2.3.1.2	Floating Hinges.....	18
2.3.2	Door Drive Mechanisms.....	19
2.3.2.1	Power Drive Units/Actuator/ Torque Limiter.....	20
2.3.2.2	Torque Shaft.....	21
2.3.2.3	Couplers.....	22
2.3.2.4	Door Open Switch.....	22
2.4	CENTERLINE MECHANISMS.....	24
2.4.1	Ganged Groups.....	26
2.4.2	Power Drive Unit/Torque Limiter.....	27
2.4.3	Passive Shear Fittings.....	29
2.4.4	Bell Crank and Linkages.....	31
2.4.5	Latch Hook and Passive Rollers.....	33
2.4.6	Latched/Unlatched Limit Switches.....	36
2.5	FORWARD AND AFT BULKHEAD MECHANISMS.....	36
2.5.1	Ganged Groups.....	36
2.5.2	Power Drive Units/Actuator/Torque Limiter.....	39
2.5.3	Torque Shaft and Latching Sequence.....	41
2.5.4	Latch Hooks and Rollers.....	41
2.5.5	Fore/Aft Alignment Rollers.....	42
2.6	PRESSURE AND CONTAMINATION CONTROL SEALS.....	44
2.6.1	Bulb Seals and Seal Depressors.....	44
2.6.2	Contamination Control System.....	46
2.6.3	Orientations of the PLBD Protective Barriers.....	47

3.7	ACTIVE THERMAL CONTROL SYSTEMS (ATCS).....	82
3.7.1	Mission Profile	82
3.7.2	Flash Evaporator Subsystem.....	82
3.7.3	Ammonia Boiler Subsystem.....	83
4.	PRECAUTIONARY MEASURES.....	84
4.1	TIMING SWITCHES	84
4.2	EVA ACTIVITIES	85
	BIBLIOGRAPHY	86

LIST OF FIGURES

2.2.1.1	Gr/Ep Honeycomb with 0.60 inch Thick Nomex.....	4
2.2.1.2	Gr/Ep Honeycomb with 0.30 inch Thick Nomex.....	5
2.2.1.3	Cross-section of the Gr/Ep Near the Hingeline.....	6
2.2.1.4	Gr/Ep Honeycomb Tapered to Seal Off the Nomex Cavity.....	7
2.2.2.1	Five Shear Pins Which Hold the PLBD Panels Together.....	8
2.2.2.2	A Close-Up of the Shear Pins.....	9
2.2.3.1	A Mounting Frame for a Floating Stud.....	10
2.2.3.2	A Mounting Frame for Radiator Panel Latch Mechanisms.....	11
2.2.4.1.1	A Radiator Panel Mounting Hinge.....	12
2.2.4.1.2	A Radiator Panel Hinge Mounted to a PLBD.....	13
2.2.4.1.3	Two Radiator Panels Actuator Arms in the Deployed Position.....	13
2.2.4.1.4	Two Lines of Latches Underneath the Radiator Panels.....	14
2.3.1.1	The Location of PLBD Hinges.....	16
2.3.1.2	Forward Thermal Protection and Aerodynamic Fairing Hinge Cover.....	16
2.3.1.3	Aft Thermal Protection and Aerodynamic Fairing Hinge Cover.....	17
2.3.1.1.1	A PLBD Hinge.....	18
2.3.1.2.1	A Floating PLBD Hinge.....	19
2.3.2.1	PLBD Drive System.....	20
2.3.2.1.1	PLBD Drive System Block Diagram.....	21
2.3.2.4.1	An Open Limit Switch.....	23
2.3.2.4.2	A Limit Switch Cut Away Drawing.....	23
2.3.2.4.3	An Aft Bulkhead Ready-To-Latch Switch.....	24
2.4.1	Centerline PLBD Latch Locations.....	25
2.4.2	PLBD Centerline Latch System.....	25
2.4.1.1	Orientations of Ganged Latch Parts.....	26
2.4.1.2	Locations of Shear Fittings.....	27
2.4.2.1	The PDU of the Aft Most Gang.....	28
2.4.2.2	PLBD Centerline Latch Actuator Schematic.....	28
2.4.2.3	PLBD Centerline Latch Block Diagram.....	29
2.4.3.1	Passive Shear Fitting Connection.....	30
2.4.3.2	Port PLBD Passive Shear Fitting.....	30
2.4.3.3	Starboard PLBD Passive Shear Fitting.....	31
2.4.4.1	PLBD Centerline Latch.....	32
2.4.4.2	Offset in the Latch Hook Actuating Mechanism.....	32
2.4.5.1	Fork and Backing Plate Rollers.....	33
2.4.5.2	Centerline Latch Hook Number 16 on OV-104.....	34
2.4.5.3	Latch Hook Roller on OV-104 with Forks and and Backing Plates.....	35

2.5.1.1	PLBD Bulkhead Latch Locations	37
2.5.1.2	PLBD Bulkhead Latch System Block Diagram.....	37
2.5.1.3	PLBD Bulkhead Latch Actuator Schematic.....	38
2.5.1.4	Starboard Forward Bulkhead Latch Gang on OV-104.....	38
2.5.2.1	Starboard Aft Bulkhead PDU on OV-104	40
2.5.4.1	Aft Bulkhead Attachment Roller.....	41
2.5.4.2	Forward Bulkhead Latch and Scallop.....	42
2.5.5.1	Aft Bulkhead Attachment Roller and Alignment Hook.....	43
2.5.5.2	Aft Bulkhead Alignment Roller and Latch Mechanism.....	44
2.6.1.1	Port PLBD Contamination Control Systems.....	45
2.6.1.2	Starboard PLBD Contamination Control Systems.....	46
2.7.1.1.1	PLBD Strongback Supports with the C-hooks and Zero "g" Apparatus In Operation	49
2.7.2.1	Torque Tubes Attached to the Orbiter in the Vertical.....	52
2.7.2.2	Torque Tube and Preloading Set Screw Interface	53
2.8.2.1	Push-pull Rod Markings on an Actuator Arm.....	56
2.8.2.2	Push-pull Rod Markings Angular Indications.....	56
3.2.1.1	Diffused Silver in the Radiator Panel Tape.....	58
3.2.1.2	Layered Tape Bonded to the Radiator Panels	59
3.2.2.1	Radiator Manifold Details	60
3.2.2.2	Typical Radiator Panel Physical Characteristics	61
3.2.2.3	Radiator Panel Honeycomb with Freon Tubes.....	62
3.2.3.1	Right Hand Radiator Panel 1 Structural Arrangement.....	63
3.2.3.2	Left Hand Radiator Panel 1 Structural Arrangement.....	64
3.2.3.3	Right Hand Radiator Panel 2 Structural Arrangement.....	65
3.2.3.4	Left Hand Radiator Panel 2 Structural Arrangement.....	66
3.2.3.5	Right Hand Radiator Panel 3 Structural Arrangement.....	67
3.2.3.6	Left Hand Radiator Panel 3 Structural Arrangement.....	68
3.2.3.7	Right Hand Radiator Panel 4 Structural Arrangement.....	69
3.2.3.8	Left Hand Radiator Panel 4 Structural Arrangement.....	70
3.3.1.1.1	Radiator Deployment Schematic.....	71
3.3.1.1.2	PDU for the Radiator Latching Mechanism.....	72
3.3.1.2.1	Linkage for the Radiator Panel Latch System.....	72
3.3.1.3.1	Deployable Radiator Latch System.....	73
3.3.1.3.2	Deployable Radiator Panel Latch.....	73
3.3.1.3.3	Deployable Radiator Panel Roller	74
3.3.2.1.1	Radiator Panel Deployment Actuation.....	75
3.4.1	Radiator Panel GSE Support Bars.....	77
3.5.2.1	Radiator Controls and Displays	78
3.6.2.1	ARID in the Robotic Applications Development Lab	80
3.6.2.2	ARID Storage Position	81
3.7.2.1	Flash Evaporator Subsystem.....	83

LIST OF TABLES

2.5.4.1	Maximum Reach for Latch Locations in Inches.....	42
2.7.2.1	Set Screw Dimension A for Torque Tube Preloading.....	53
4.1.1	PLBD and Radiator Panel Mechanisms' Operating Times.....	84

LIST OF ACRONYMS

ABS	Ammonia Boiler Subsystem
ATCS	Active Thermal Control System
ATP	Accelerated Training Program
cg	Center of Gravity
COAS	Crew Optical Alignment System
CRES	Corrosion Resistant Steel
DEP	Deployed
EVA	Extravehicular Activity
FES	Flash Evaporator Subsystem
GPC	General Purpose Computer
Gr/Ep	Graphite Epoxy
GSE	Ground Support Equipment
JSC	Johnson Space Center
KSC	Kennedy Space Center
NASA	National Aeronautics and Space Administration
OMI	Operation and Maintenance Instructions
OMRSD	Operation and Maintenance Requirements and Specifications Documentation
OPF	Orbiter Processing Facility
PCR	Payload Changeout Room
PDU	Power Drive Unit
PLBD	Payload Bay Door
PR	Problem Report
REL	Released
RTOMI	Repetitive Task Operation and Maintenance Instructions
STBD	Starboard
TFE	Tetrafluoroethylene
Zero "g"	Zero Gravity

1. INTRODUCTION

This handbook details the structure and mechanisms associated with the Payload Bay Doors (PLBDs) and the Radiator Panels. The detailed design of both systems contributes to the success of the Shuttle Program and each mission.

The PLBDs allow the radiator panels to be exposed to space, protect payloads from contamination, and provide an aerodynamic fairing over the payload bay. The radiator panels dissipate heat from the orbiter and regulate hydraulic fluid temperature. Contamination in the payload bay can hinder the success of missions, therefore, the contamination control barrier which the PLBDs provide must be efficient in keeping the bay free from contaminants. The aerodynamic fairing the PLBDs provide prevents the orbiter from being torn apart by aerodynamic forces. These facts make the PLBDs and radiator panels mission critical elements of the Space Shuttle.

2. PAYLOAD BAY DOORS (PLBDs)

2.1 OVERALL STRUCTURE AND PERTINENT DETAILS

The Payload Bay Doors (PLBDs) are approximately 61 feet long and have an approximate surface area 1600 square feet. These dimensions are approximated because the forward bulkhead is canted forward which varies the forward PLBD X_0 location from 574.090 at the centerline to 579.300 at the hingeline. The two doors (left and right) are hinged to the orbiter midbody just above the sill longeron. When the doors are in the closed configuration, they are latched along the centerline and the forward and the aft (X_0 1306.900) bulkheads.

Each door consists of five individual panels, of which the forward most four are approximately 15 feet long and the aft most panel is approximately 2 feet long. As can be seen in Fig. 3.2.2.2, the radius of curvature varies throughout each Y-Z plane and has an arc length of 10.5 feet. The doors are divided into the panels to give the orbiter and the doors the ability to expand at different rates and to allow the orbiter to bend and twist, all without applying external loads to the doors. These five panels are connected to each other with shear pins which allow for the relative movements of the door panels and the orbiter, but also hold the door as a one piece unit during door opening/closing operations.

The PLBDs are not designed as an orbiter structural member and therefore, do not provide structural stability for the orbiter. The design allows for longitudinal movement at the forward bulkhead and the expansion joints between the five panels. The expansion joints also allow the doors to accommodate torsional loads. Both longitudinal and torsional movements are achieved without imparting loading on the PLBD structure.

The PLBDs are installed on the orbiter for an aerodynamic fairing between the forward and aft fuselages and a contamination control barrier. For the orbiter to be aerodynamically stable, an aerodynamic fairing must cover the payload bay to allow for a non-turbulent airflow over the fuselage in order to decrease the profile drag. A protective barrier between the payload and outside environment must be provided because payloads are highly sensitive to contamination. This barrier is the PLBD system which contains many subsystems (see Chapter 2.6) for contamination control.

The doors are the largest aerospace structure made from composite materials. The use of a Graphite-Epoxy (Gr/Ep) composite reduces the weight of the structure 23% over a normal aluminum

honeycomb material. The port door weights approximately 2,375 pounds while the starboard door weighs approximately 2,535 pounds. These weights are approximated because of the varying weights of the insulation blankets and the moisture absorbed by the composite material. The difference in the weight of the two doors is due to the active centerline latch mechanisms attached to the starboard door and the passive system attached to the port door. These weights do not include the weight of the radiator panels, which adds an additional 833 pounds per door.

The PLBDs are built to withstand a 163 decibel (dB) noise level during launch and a temperature range of -170° F to 135° F while on orbit.

The PLBDs are insulated on the outside with reusable surface insulation and on the inside with insulation blankets located underneath the radiator panels.

The PLBDs were designed and built by Rockwell International Corporation - Space Division in Tulsa, Oklahoma. Curtiss Wright of Caldwell, NJ, built the PLBD power drive units, rotary actuators, drive shafts, torque shafts, couplings, radiator deploy/latch actuator and latch mechanism. The PLBD electromechanical rotary actuators were built by Hoover Electric in Los Angeles, CA.

2.2 INTERNAL STRUCTURAL MEMBERS

2.2.1 Thin-walled Structural Elements

A Graphite-Epoxy (Gr/Ep) composite is used to provide a strong structure with a substantial weight savings over conventional aluminum. The Gr/Ep is used for the face plates of the honeycomb sandwich panels, the solid laminate beams, the seal depressor (see Fig. 2.6.1.2), and the gussets. Each of these pieces are composed of graphite fibers in a matrix of epoxy at orientations of 0, 45, and 90 degrees.

The PLBD panels are constructed in a honeycomb sandwich fashion with the face plates and the honeycomb material made from Gr/Ep and Nomex, respectively. The majority of these panels are made with 0.60 inch thick Nomex and three Gr/Ep plies (0, 45, 0 degree ply orientations). However, a small area near the hingeline is made with 0.30 inch thick Nomex and five Gr/Ep plies (90, 0, 45, 0, 90 degree ply orientation). This area makes a torque box for the hinges and EVA handholds to attach.

In some areas, the honeycomb sandwich needs to be tapered down to Gr/Ep laminates without the Nomex filler. To create these "flat"

areas (areas without the Nomex filler), the honeycomb sandwich is tapered at a 30° angle to a solid Gr/Ep layup (see Figs. 2.2.1.1 and 2.2.1.2). In these tapered areas, additional laminate layers are used to maintain structural integrity. These tapered areas are used to attach structural reinforcement (ribs, longerons, and intercostals) and to seal off the Nomex "cavity" around the edges of each panel (see Figs. 2.2.1.3 and 2.2.1.4).

Figure 2.2.1.1:

**Graphite Epoxy Honeycomb with
0.60 inch Thick Nomex**

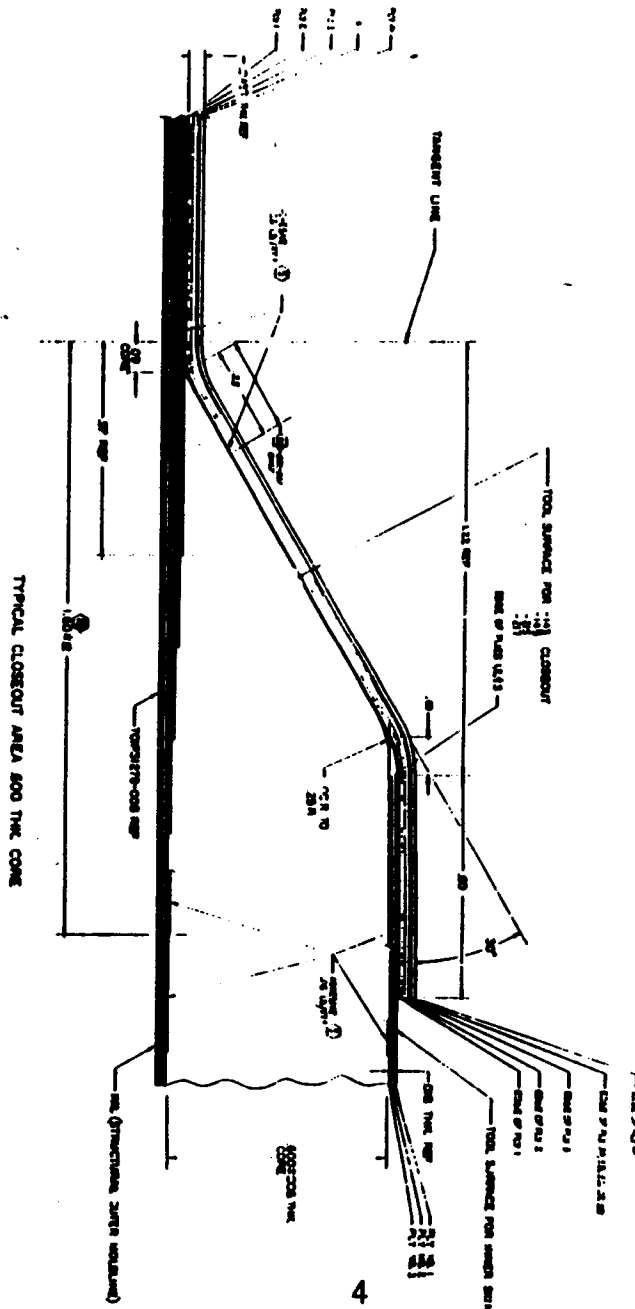

ORIGINAL PAGE IS
OF POOR QUALITY

Figure 2.2.1.2:

**Graphite Epoxy Honeycomb with
0.30 inch Thick Nomex**

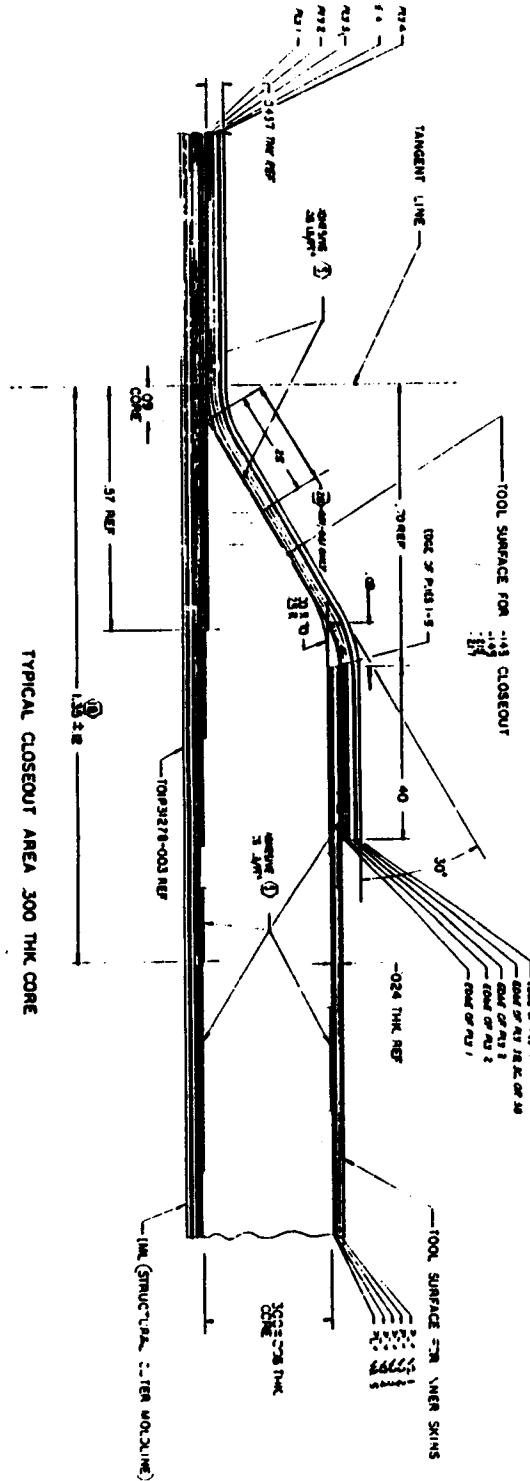

Figure 2.2.1.3:

A Cross-section of the Graphite Epoxy Near the Hingeline Torquebox

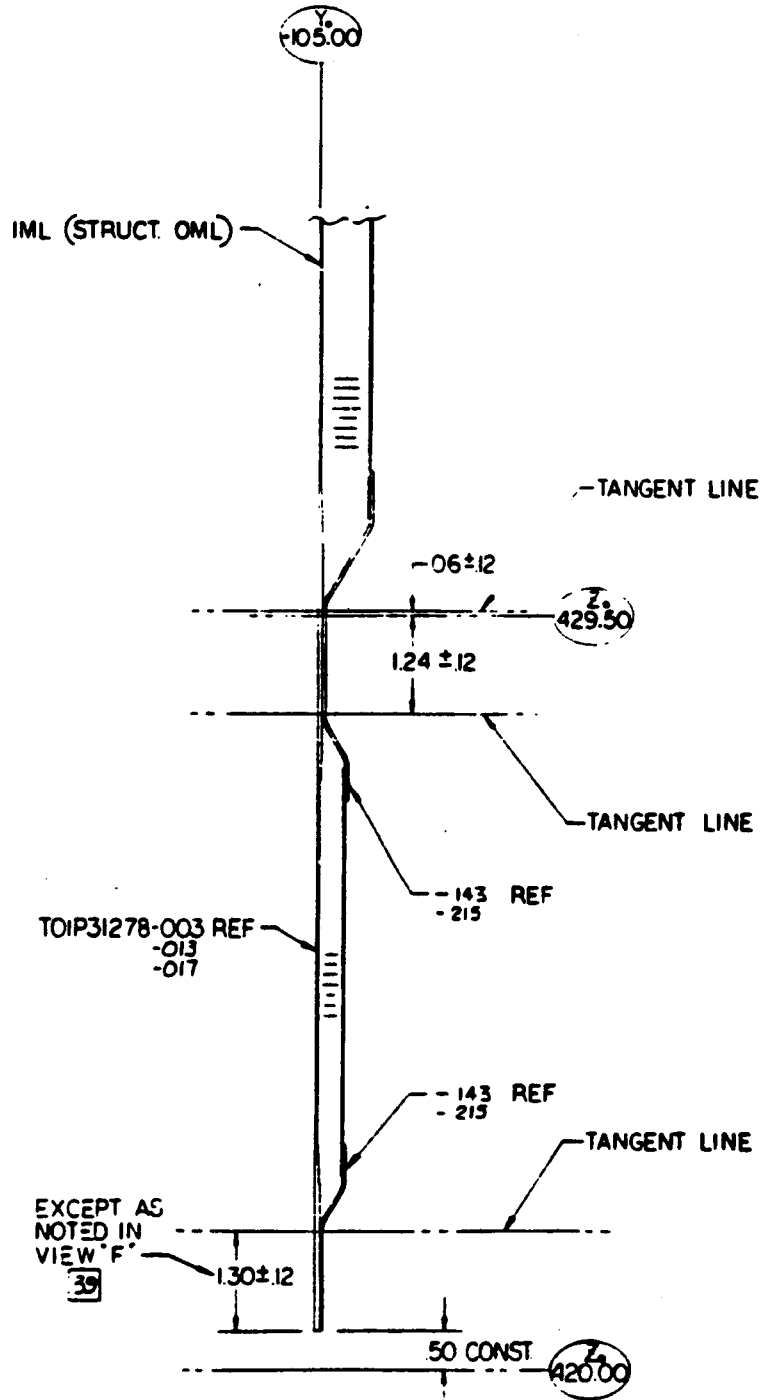
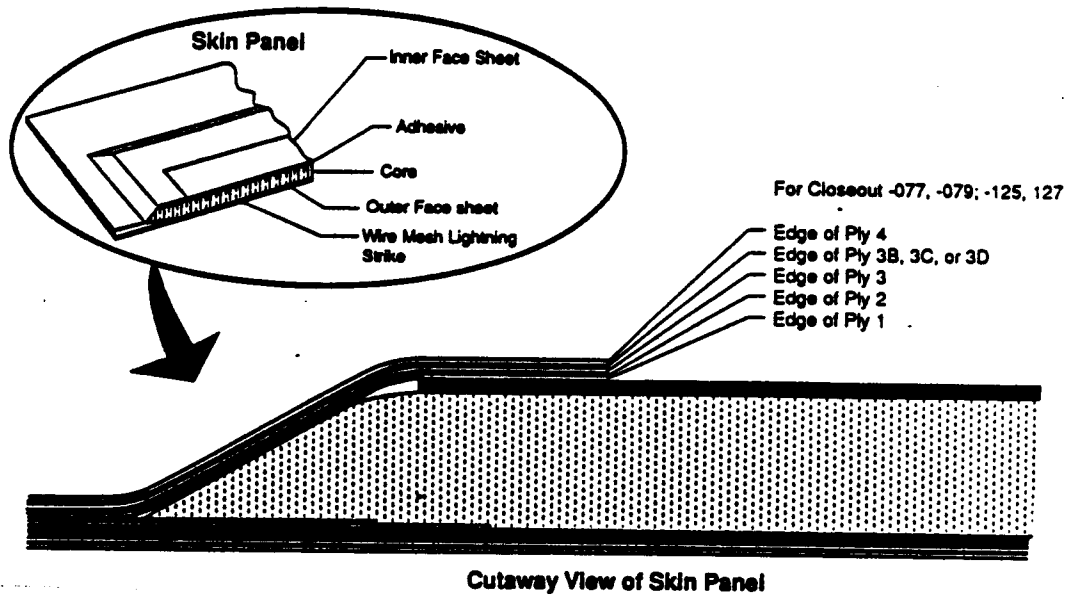

Figure 2.2.1.4:

Graphite Epoxy Honeycomb Tapered to Seal Off the Nomex Cavity



The ribs, longerons, and intercostals are made from solid Gr/Ep laminates. The composite achieves the strength, in the specific directions, equal to aluminum beams, but with a substantial weight savings. The composite ribs and longerons are hi-locked, or "bolted," to the PLBD panels and connected together with Gr/Ep corner brackets or gussets.

A 200 by 200 calendered aluminum mesh is bonded to the inside of the outer skin. Each panel's mesh is connected together by the use of metal clips which slide back and forth to allow for thermal expansion/contraction, bending, and twisting of the orbiter and the PLBDs. A grounding strap is attached to the mesh near the forward bulkhead to provide lightning protection.

2.2.2 Shear Pins and Thermal Expansion

Thermal expansion/contraction was a challenging problem to overcome during the design phase of the Space Shuttle structure and the PLBD system. The PLBDs were especially challenging to design due to the differing thermal properties between the aluminum orbiter and the

composite PLBDs. This design challenge was solved by allowing the orbiter and PLBDs to expand/contract, bend, and twist and concentrating on the continuously changing structure. To compensate for the structural changes, the doors were designed with five panels connected by shear pins. This can be seen in Figs. 2.2.2.1 and 2.2.2.2.

The shear pins are the structural members which tie the five panels on each door together. The pins are fixed to one panel, extend to an adjacent panel, and are attached to the adjacent panel with a sleeve. The sleeve allows the pin to move strictly in the x-direction. Each of the eight panel to panel interfaces (four in each door) have five shear pins.

Figure 2.2.2.1:

**The Five Shear Pins Which Hold
the PLBD Panels Together**



Figure 2.2.2.2:

A Close-Up of the Shear Pins

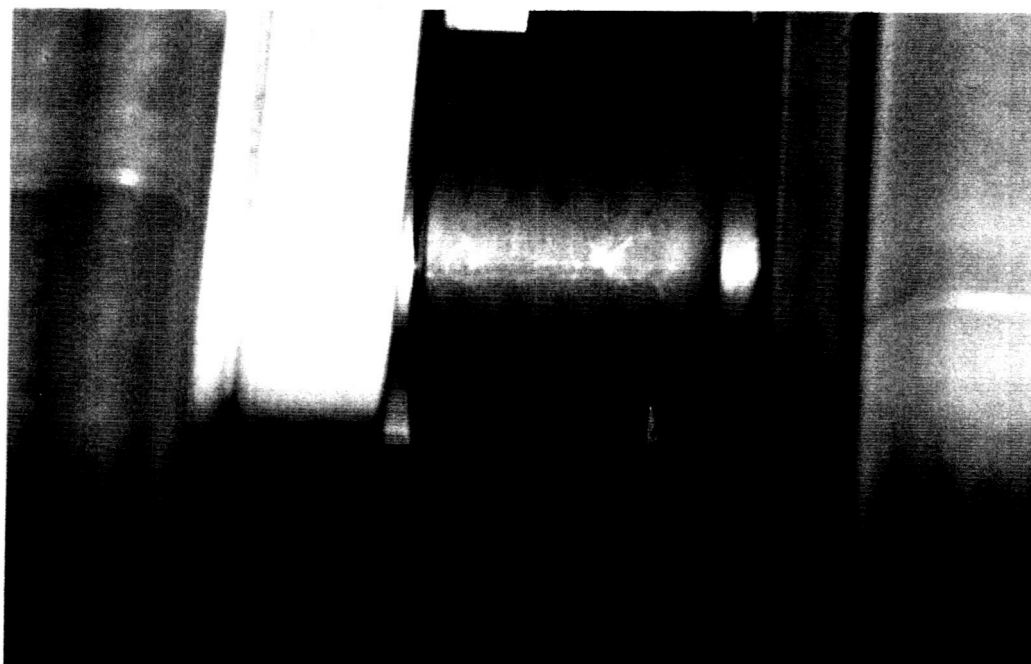

2.2.3 Ribs, Longerons, and Intercostals

Normal aircraft structures are held together with ribs, longerons, and intercostals. The PLBDs are not much different than normal aircraft structures. The internal structures can be less "beefy" than their normal counterparts because the PLBDs do not contribute to the structural integrity of the Space Shuttle. The ribs on the PLBDs are spaced at intervals of 22.5 inches, except for the first and last two ribs which vary in spacing due to the additional loading imparted on them by the shear pins. These ribs provide vertical and lateral support for the PLBDs. Intercostals are used in locations where additional concentrated loads are assumed and can not be supported by the ribbing and the composite skin. The PLBDs contain two longerons to provide support, which is the main structural difference between the orbiter and normal aircraft structures.

The ribs in the PLBDs are used primarily to add structural stability to the thin walled skin structure and to prevent warping of the composite. The ribbing of the PLBDs, unlike conventional aircraft structures, does not undergo large torsional loads created by other structures.

The framing within each door acts similarly to a torque box, transmitting loads away from a discrete point. This framing is achieved by connecting intercostals between two adjacent ribs in order to provide additional structural support. The framing consists of 28 intermediate frames, 8 expansion joint frames, and 1 forward and 1 aft closeout frame. The intermediate frames are positioned to take the loads imposed on the PLBDs by the radiator panels and its sub-systems. These frames hold the mounting brackets for the fixed (aft) radiator panels (see Fig. 2.2.3.1) and the latches for the deployable (forward) radiator panels (see Fig. 2.2.3.2). The shear pins which hold the panels together impart discrete loads to each panel. An expansion joint frame must therefore be positioned at the point of contact between the shear pins and the PLBDs to transfer the loads throughout the structure. The closeout framing is used between the first and last two ribs of each door to accept the loads imposed on the PLBDs by the bulkhead latches, which are mounted on the doors.

The primary function of the longerons on the PLBDs is to provide structural rigidity to the doors and their attach points for the centerline latch, door hinge, and door drive mechanisms. The ribs mount to the two longerons which make up a large frame. This large frame in turn accepts, with help by the thin walled skin, all the loads imparted on the PLBDs.

Figure 2.2.3.1:

A Mounting Frame for a Floating Stud

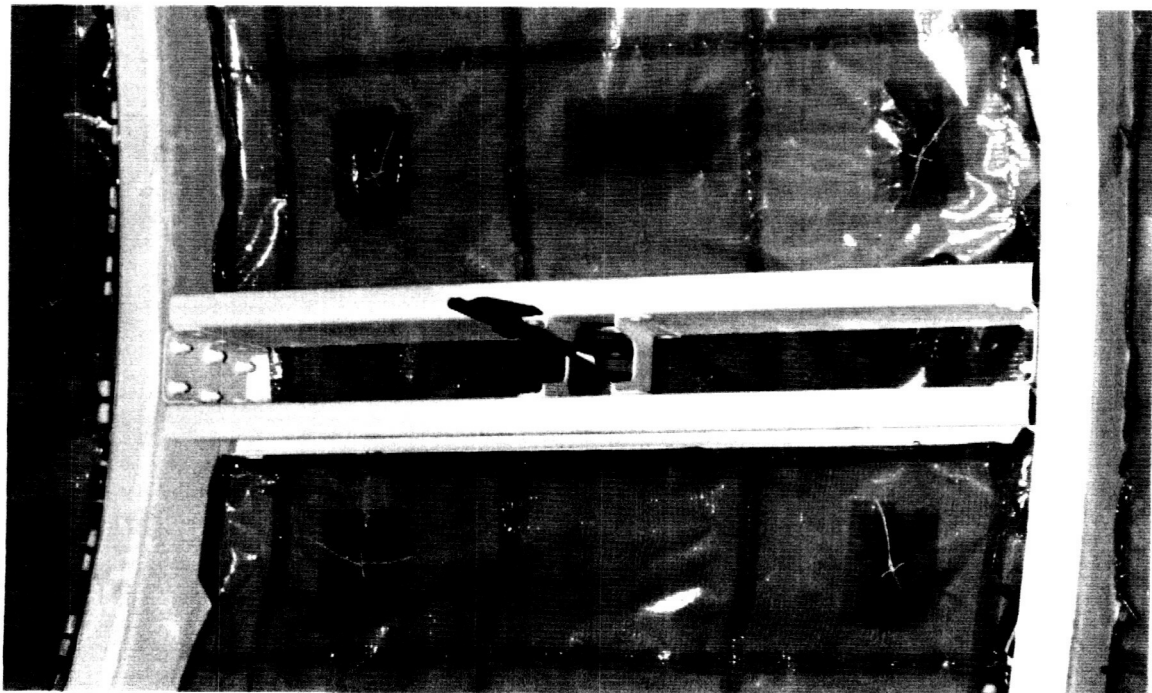
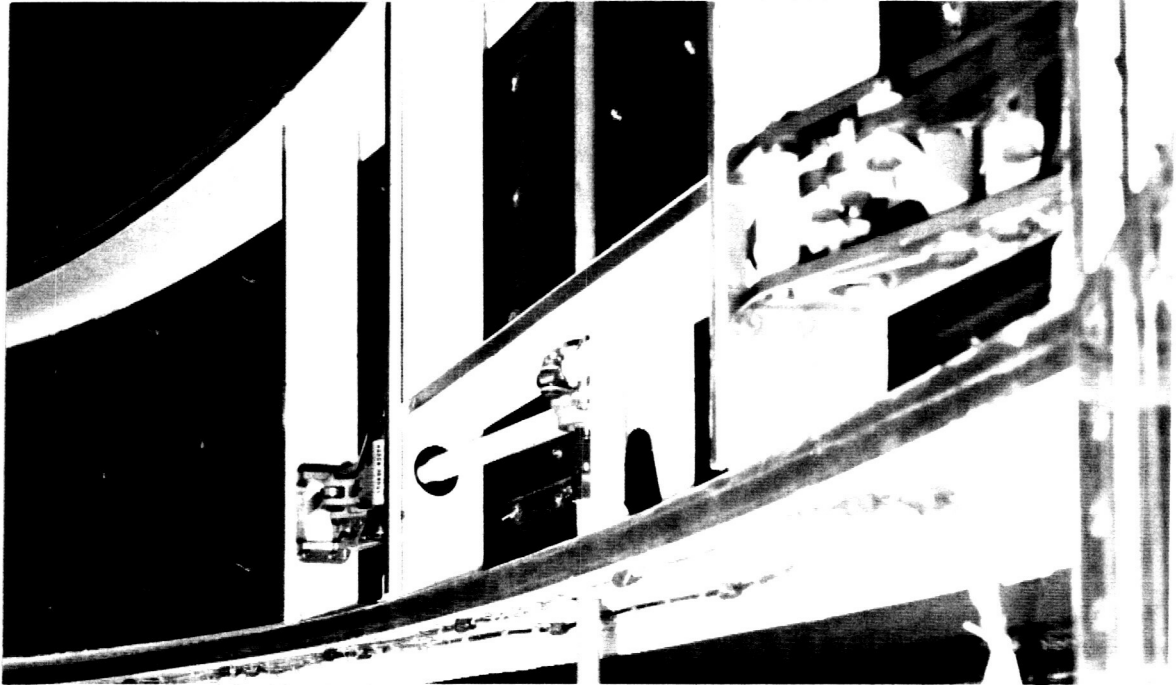

Figure 2.2.3.2:

**A Mounting Frame for Radiator Panel
Latch Mechanisms**



2.2.4 Radiator Attach Points

2.2.4.1 Deployable Radiator Panels

The 4 deployable radiator panels are each attached to the PLBDs in 11 places when in the stowed position and 5 when deployed. The 5 permanent radiator panel attach points to the PLBDs include 3 hinges and 2 actuators, which are both positioned near the door longeron. Only one of the 3 hinges has a shear tie to incorporate the x-loads. This allows for thermal expansion, bending, and twisting of the radiator panels as well as the doors. When the radiator panels are stowed, each panel is latched to the PLBDs in six places (2 rows of 3 latches). Each door, which holds 2 deployable radiator panels, has two lines of 6 latches.

An individual radiator panel hinge is shown in Fig. 2.2.4.1.1, while Fig. 2.2.4.1.2 shows the hinge mounted to the PLBDs. The two actuator arms (in the deployed position) are shown in Fig. 2.2.4.1.3. The two lines of latches can be seen in Fig. 2.2.4.1.4. Figs. 3.2.3.1 through 3.2.3.4 illustrate the positions of the hardware attached to Panels 1 and 2.

Figure 2.2.4.1.1:

A Radiator Panel Mounting Hinge

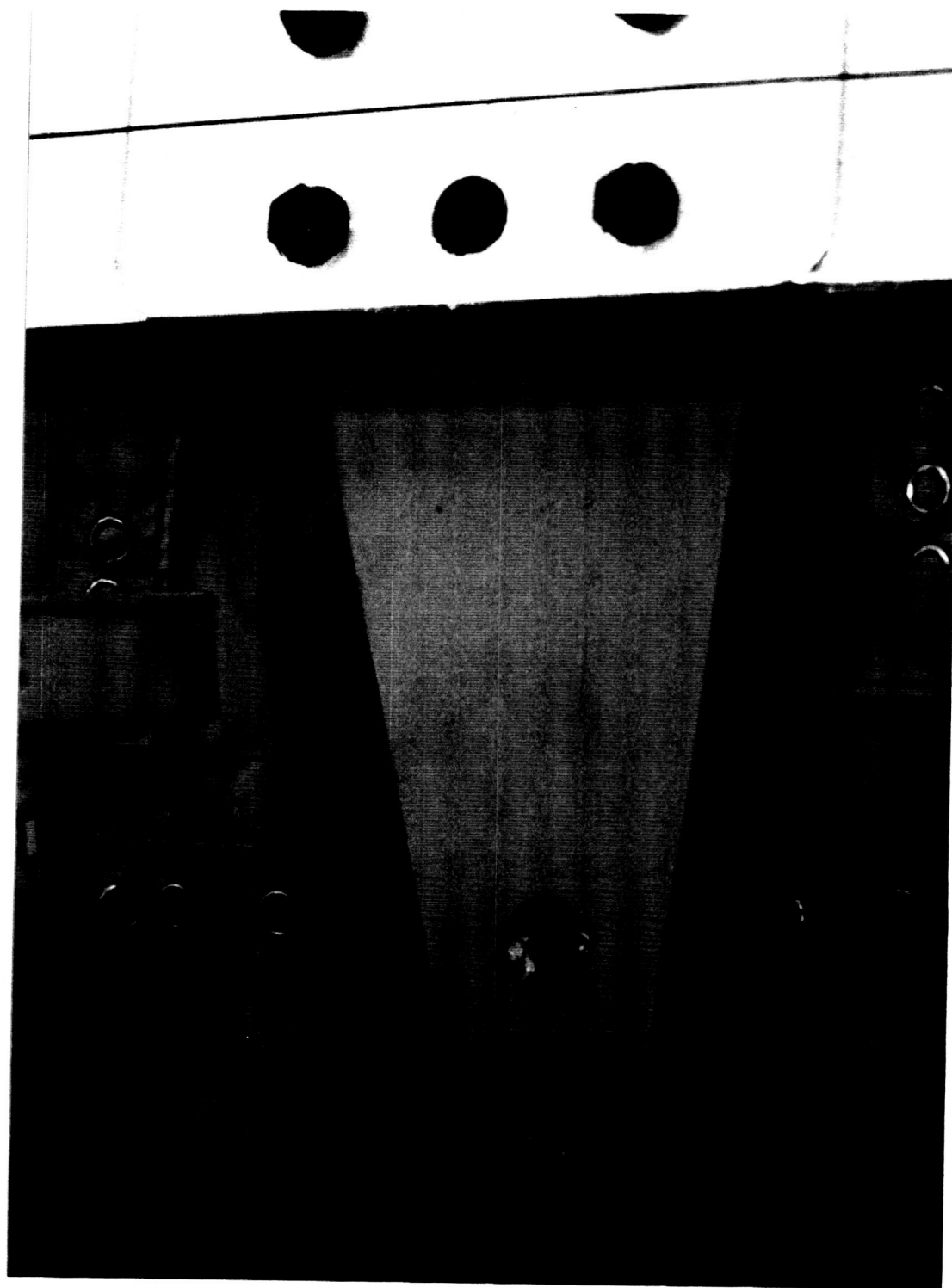

Figure 2.2.4.1.2:

**A Radiator Panel Hinge Mounted
to the Payload Bay Door**



Figure 2.2.4.1.3:

**Two Radiator Panel Actuator Arms
in the Deployed Position**

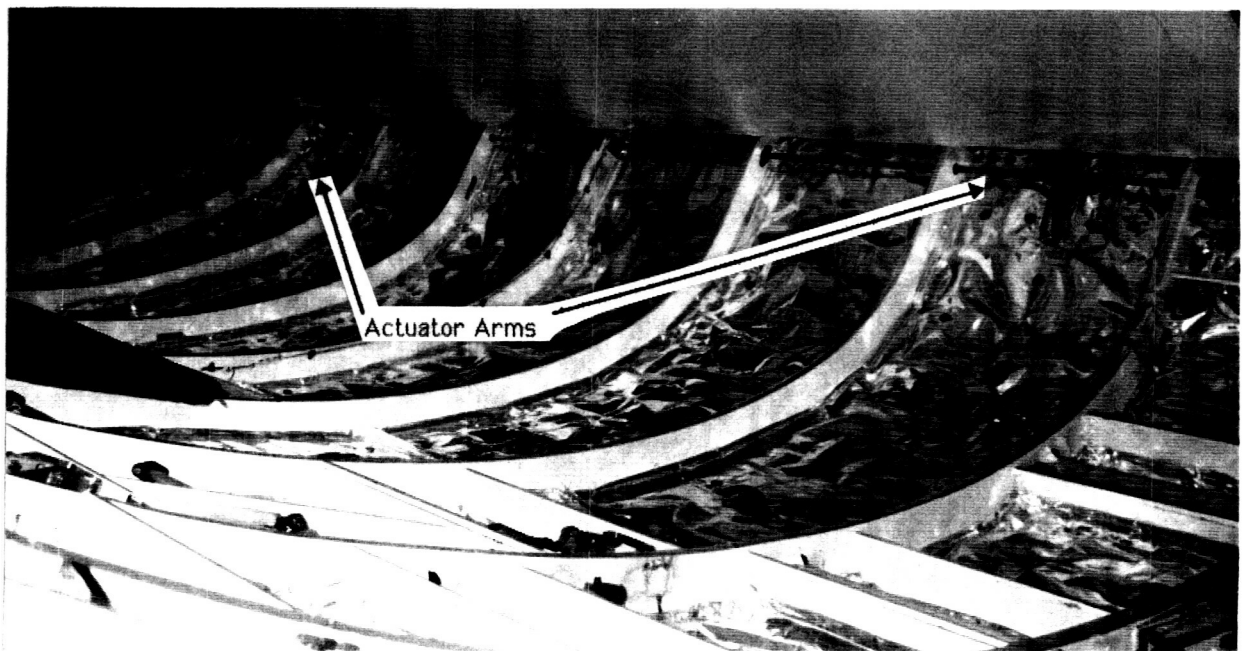

Figure 2.2.4.1.4:

**Two Lines of Latches Underneath
the Radiator Panels**



2.2.4.2 Fixed Radiator Panels

The fixed radiator panels are attached to the doors through the floating studs shown in Fig. 2.2.3.1, as well as hinges connected near the door longeron. The aft most radiator panel (Panel 4) is positioned over PLBD Panels 4 and 5 and is therefore larger than the other 3 radiator panels. This size difference calls for a different attachment scheme than Panel 3. Radiator panel 3 is attached to the PLBDs with 4 hinges and 12 floating studs (see Figs. 3.2.3.5 and 3.2.3.6). Panel 4, on-the-other-hand, is attached with 5 hinges and 10 floating studs (see Figs. 3.2.3.7 and 3.2.3.8). Both panels, like the deployable panels, each contain one shear tie for x-loads to allow for thermal expansion, bending, and twisting.

ORIGINAL PAGE
COLOR PHOTOGRAPH

2.3 DOOR LONGERON MECHANISMS

2.3.1 Hinges

The PLBD hinges are designed to connect the PLBDs to the orbiter's midbody, to allow for free rotation of the PLBDs during opening/closing operations, and to not impart the stresses caused by the thermal expansion, bending, and twisting of the orbiter to the doors. While neglecting external stresses, the first two design features can be satisfied with a "normal," or fixed hinge. A fixed hinge is an apparatus which prevents movement along all three axis and allows rotation only about the axis of the hinge pin. If all the hinges on the PLBDs were of the fixed type, external stresses would be imposed on the PLBDs; therefore, "non-normal" hinges must be utilized. These "non-normal" hinges are called floating hinges. Floating hinges used on the PLBDs allow translation along and rotation about the x-axis (the axis of the hinge pin orientation) and prevent these movements about the other two axes. Since these hinges allow movement along the x-axis the orbiter's shape changes are not adopted by the doors. The orientation of the door hinges is shown in Fig. 2.3.1.1.

An aerodynamic fairing and thermal protection system is a modification of the portion of the hinges located outside of the orbiter. Thermal discoloration of the hinges during the first few missions required this modification. The fairings are a ceramic material. The size of the ceramic covering changes with the location of the hinge on the orbiter due to varying heating conditions. Figs 2.3.1.2 and 2.3.1.3 show a typical forward and aft hinge covering, respectively, on OV-105.

Figure 2.3.1.1:

The Location of PLBD Hinges

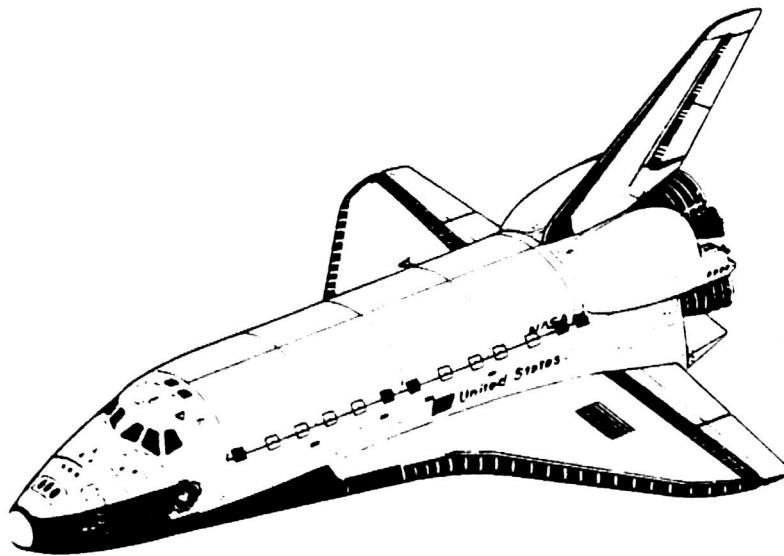

13 hinges

■ = fixed hinge

□ = floating hinge

Figure 2.3.1.2:

Forward Thermal Protection and Aerodynamic Fairing Hinge Cover

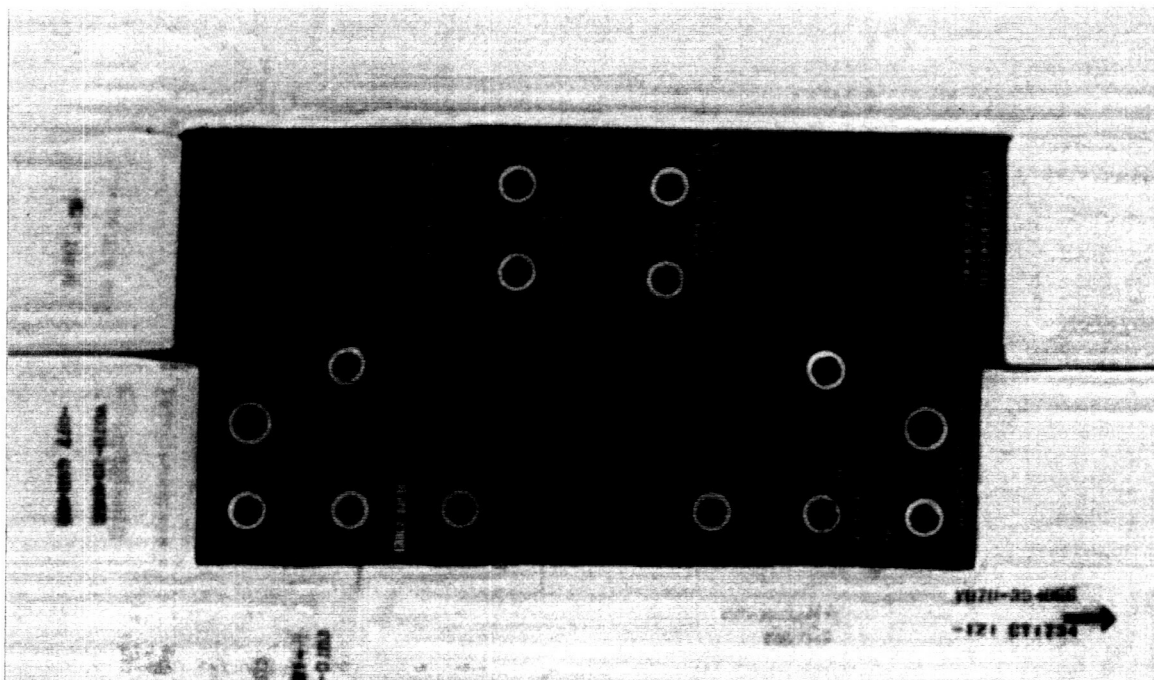
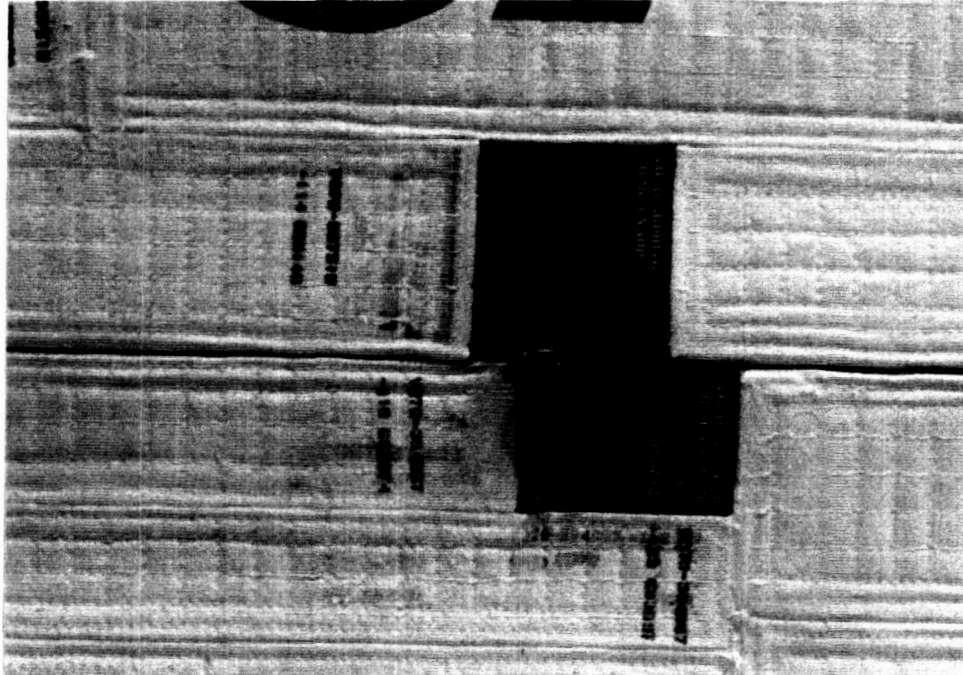

Figure 2.3.1.3:

**Aft Thermal Protection and
Aerodynamic Fairing Hinge Cover**



Each PLBD can be thought of as three "segments." The first of these segments is made up of PLBD panels 1 and 2 and the second consists of panels 3 and 4. The third segment consists strictly of panel 5. Segments 1 and 2 are hinged to the orbiter at the forward and aftmost hinge locations of each segment by fixed hinges. Four floating hinges are positioned between two fixed hinges. Since the forward and aftmost points are held fixed relative to the orbiter, the majority of the orbiter's and the PLBD's thermal expansion/contraction, bending and twist are accommodated by the PLBDs with the first and third circumferential expansion joints. The third PLBD segment, which is approximately two feet long, is held to the orbiter by one fixed hinge and no loads can be transferred to this segment from the orbiter's thermal expansion/contraction, bending, and twisting.

2.3.1.1 Fixed Hinges

A fixed hinge holds the attach point to an exact position relative to the structure to which it is attached and only permits rotation in one direction; therefore, the hinge is exerting a force along all three axis and a moment about the two non-rotating axes. Five hinges on each PLBD are fixed hinges. Since these hinges hold the attach point on the PLBDs to a constant location relative to the orbiter's midbody, a precise X_0 , Y_0 , and Z_0 coordinate for the attach point and the hinge can be found. The hinges also allow for rotation about the X-axis and prevent rotation about the Y and Z-axes, which allows only for the opening and closing rotational movement.

A fixed hinge is shown in Fig. 2.3.1.1.1.

Figure 2.3.1.1.1:

A Fixed PLBD Hinge

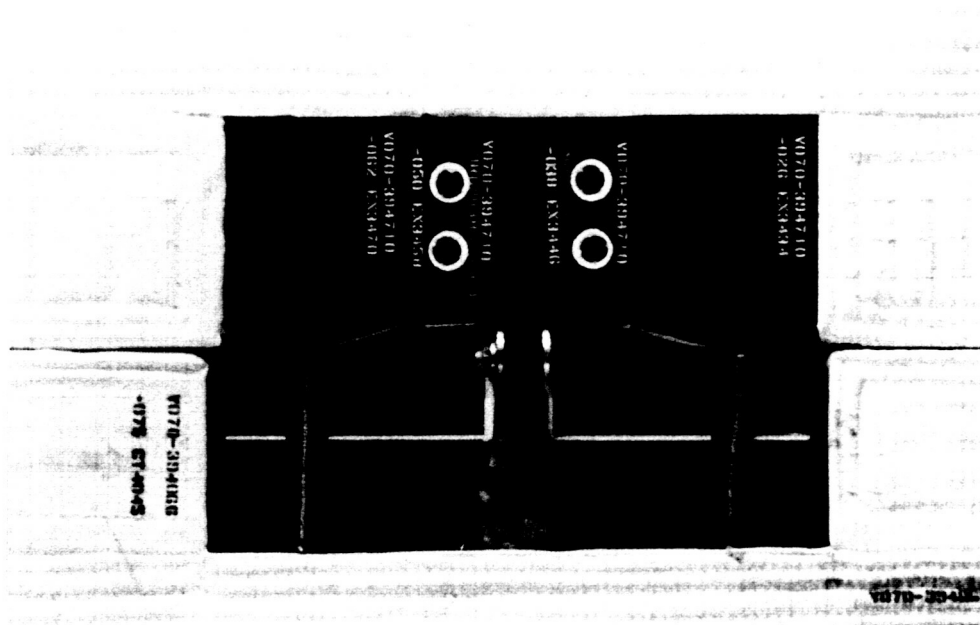

2.3.1.2 Floating Hinges

A floating hinge is similar to a fixed hinge; however, the ring which runs around the hinge pin is allowed to move freely along the pin's longitudinal axis. On the orbiter, the PLBD hinge pins are oriented along the X, or longitudinal, axis. This freedom of movement in the X-axis

allows the orbiter to thermally expand/contract, bend, and twist around the door without applying any loads to the doors. The ability for the ring to move along the hinge pin prohibits an exact attach point location in the X-axis from being determined; however, the coordinates of the hinge hardware are known. The floating hinges, like the fixed hinges, only allow rotation about the hinge pin axis.

A floating PLBD hinge is shown in Fig. 2.3.1.2.1.

Figure 2.3.1.2.1:

A Floating PLBD Hinge

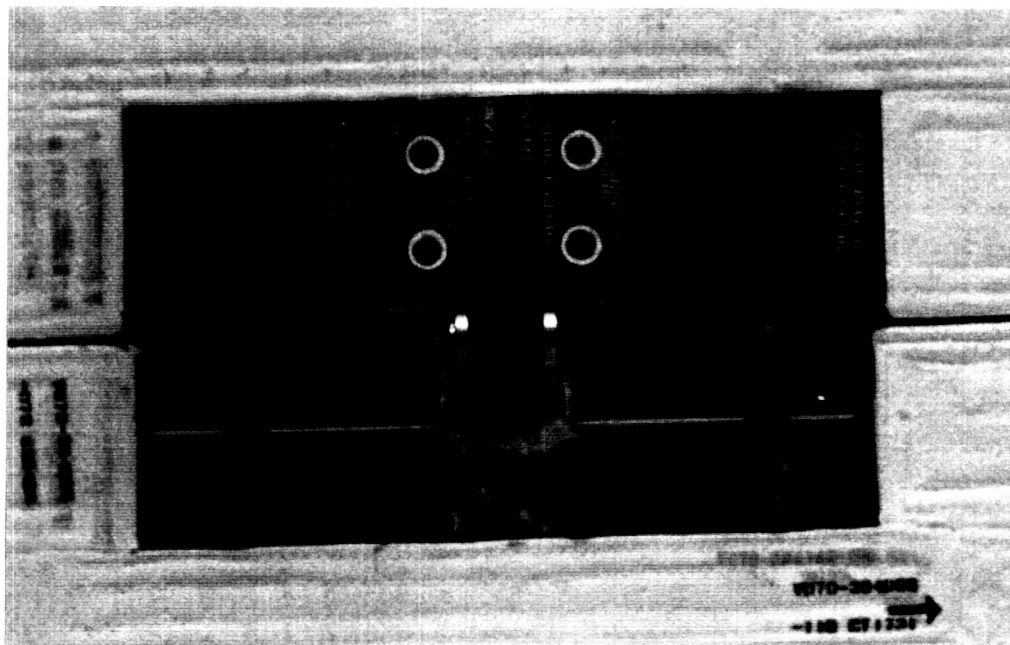

2.3.2 Door Drive Mechanisms

The door drive mechanisms are responsible for opening and closing the PLBDs under the weightless conditions of space. The mechanisms operate the door between the unlatched position of approximately 4° (ready-to-latch position) and any angle up to the $175.5^\circ \pm 0.5^\circ$ position (full open position).

The door drive mechanism for each door consists of one electromechanical PDU (power drive unit), six rotary gear actuators with torque limiters, torque tubes, thirty-six shaft couplers, twelve support bearings, and two door closed and two door open limit switches (see Fig. 2.3.2.1). The PDU is connected, using torque tubes, to the actuators, which are connected to the PLBDs through linkages. The

system is designed to open the door even in the case of a ceased or jammed actuator. In this case, the torque limiter connected to the jammed actuator will slip and the other five actuators will take over and open the door. However, in some severe cases the five actuators can not provide enough force to open the doors. This would result in a complete door stall-out.

Figure 2.3.2.1:

PLBD Drive System

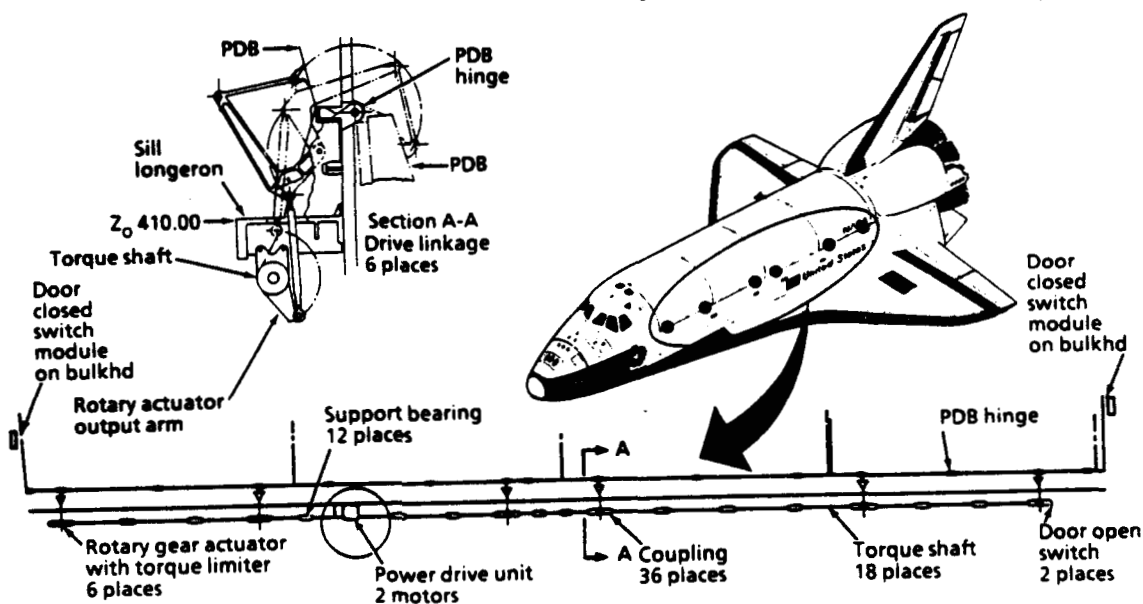

2.3.2.1 Power Drive Units/Actuator/Torque Limiter

Each Payload Bay Door drive mechanism utilizes one Power Drive Unit (PDU), which consists of two three-phase electrical motors (115 VAC and 400 Hz) which are each connected to an independent power bus. The PDU is located at X₀ 800. These two motors are connected together and also to a torque tube through a differential. This allows the system to be run on one or two motors. The system automatically runs on one motor if one motor fails or if only one power bus is activated. The differential, positioned at the juncture of the parallel motors and the torque shaft, allows for an automatic switch to single motor operation. However, the time for the mechanism to open the doors on a single motor is doubled (from 63 seconds to 126 seconds).

The torque shaft runs from the differential into six parallel torque limiters (see Fig. 2.3.2.1.1). The torque limiters will not allow torque to be transmitted from the torque shafts to the PLBD

opening/closing linkages if there is a substantial resisting force opposing movement in the linkage.

Figure 2.3.2.1.1:

PLBD Drive System Block Diagram

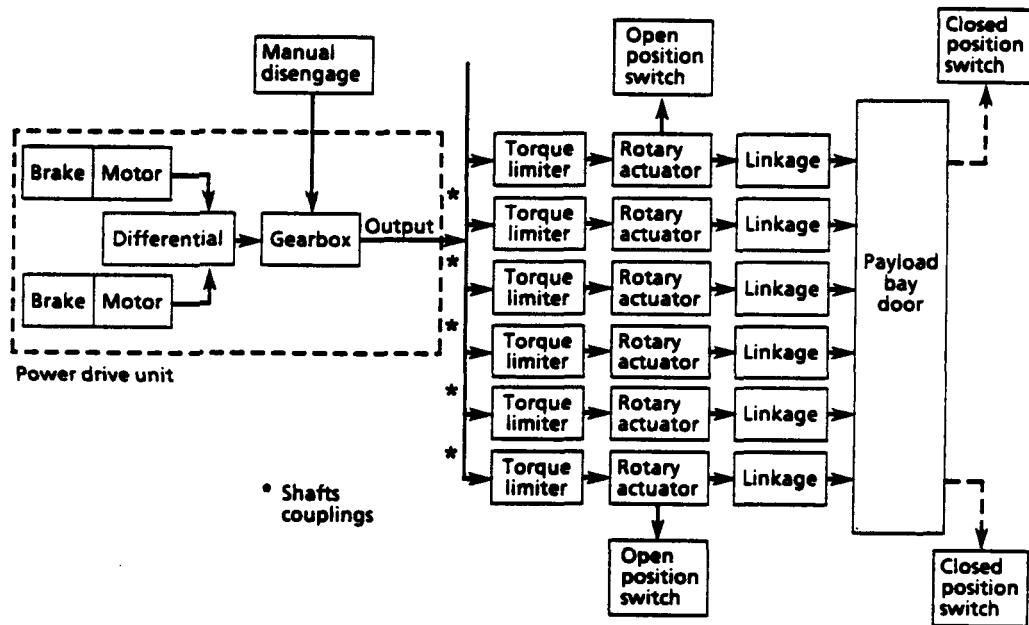

The torque shaft runs through the actuator which is connected to a bell crank. As the actuator is turned by the torque shaft, the bell crank arm moves. This bellcrank movement transfers the rotation of the bellcrank into linear movement of the push-pull rod. The push-pull rod is the actual mechanism which is connected to the PLBD hardware and therefore, pushes/pulls the PLBDs open/closed.

2.3.2.2 Torque Shaft

The torque shaft for the PLBD drive system, spanning 55 feet and running beneath the sill longeron, is many Inconel 718 (a Nickel Chromium Stainless Steel) torque shafts connected by thirty-six couplers and supported by twelve support bearings, the six rotary actuators, and the PDU. They are the linkage between the differential of the PDU and the bellcrank of the actuator.

2.3.2.3 Couplers

Couplers are used in PLBD drive system for three reasons. A 55 feet long torque shaft is much harder to work with than many 2 or 3 feet sections. The couplers are used to link the smaller pieces together. Minor timing adjustments in the actuation sequence to insure all the actuators are driven at the same time can be performed at each coupler/torque tube interface. The couplers and torque shafts have teeth in order to engage each other, and through these teeth the minor timing and rigging adjustments can be made. Thermal expansion/contraction, bending, and twisting must be accounted for in all the PLBD systems. The teeth in the couplers are given some longitudinal (x-direction) play to allow them to slide in and out to accommodate the orbiter and PLBD movements.

2.3.2.4 Door Open Switch

The forward and aft door drive rotary actuators both contain an open switch which relays positions of 88° (maximum opening angle in the PCR due to a room size constraint) and 175.5° (see Fig. 2.3.2.4.1). The 88° indication represents the angle to which the PLBDs are opened in the PCR (Payload Changeout Room), while the 175.5° angle is the full-open angle for the doors.

The switches which tell the doors that they are in the closed position are the ready-to-latch switches (see Fig. 2.3.2.4.2) and run on 28 VDC. These switches are located on the forward and aft bulkheads. A ready-to-latch switch is shown in Fig. 2.3.2.4.3. The PLBDs apply a force to the striker plate of each switch, which indicates that the doors are within 4° of being in the closed and latched position.

Figure 2.3.2.4.1:

An Open Limit Switch

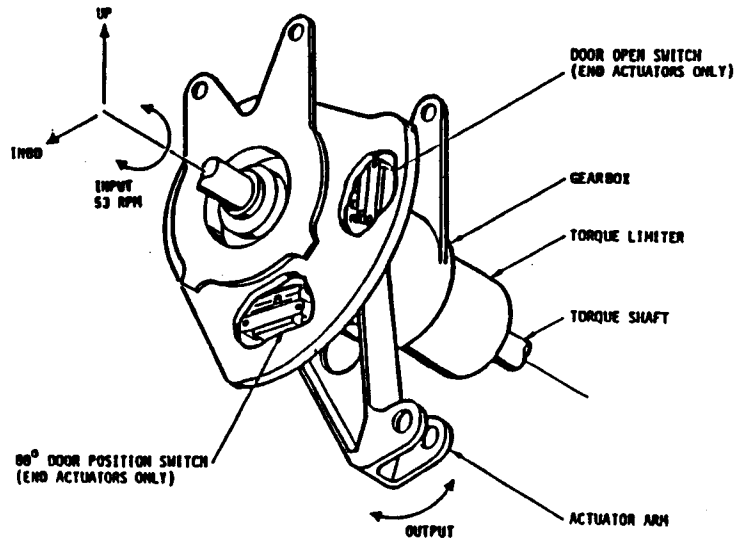

Figure 2.3.2.4.2:

A Limit Switch Cut Away Drawing

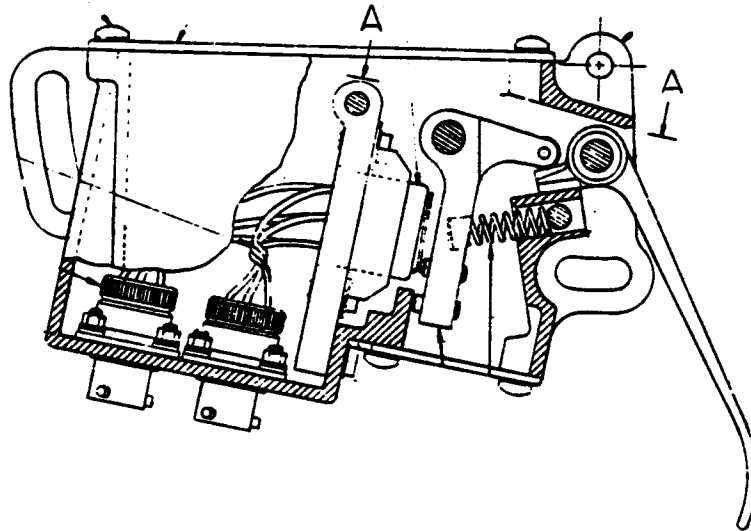
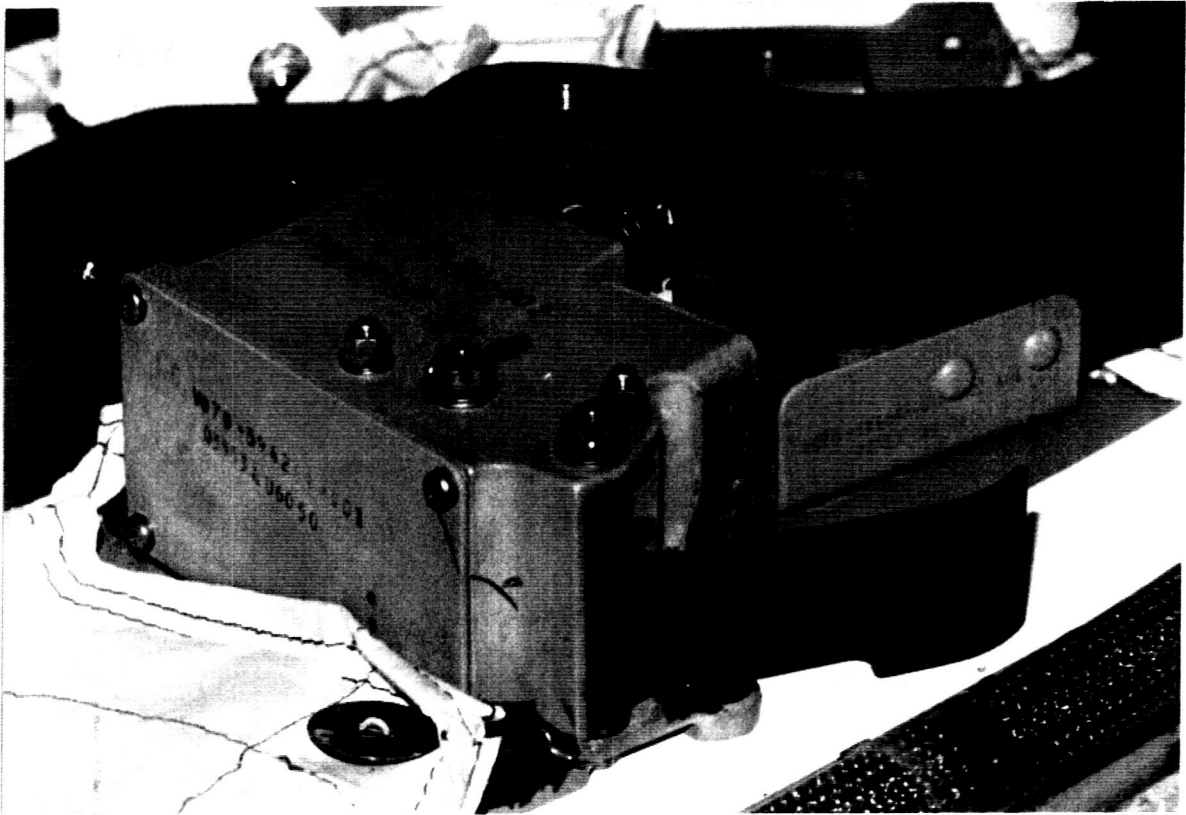

Figure 2.3.2.4.3:

An Aft Bulkhead Ready-To-Latch Switch



2.4 CENTERLINE MECHANISMS

The centerline mechanisms are responsible for latching the left and right PLBDs together. The centerline latch system consists of sixteen latches numbered 1 through 16 from the forward to the aft (see Fig. 2.4.1). The latch system is broken down into four ganged groups. Each ganged group consists of a Power Drive Unit (PDU), four active latches with their accompanying passive rollers, bellcranks, pushrods, and levers, and a passive shear fitting (see Fig. 2.4.2). The active portion of the centerline latch system is located on the starboard door, while the passive mechanisms are on the port door.

ORIGINAL PAGE
COLOR PHOTOGRAPH

Figure 2.4.1:

Centerline PLBD Latch Locations

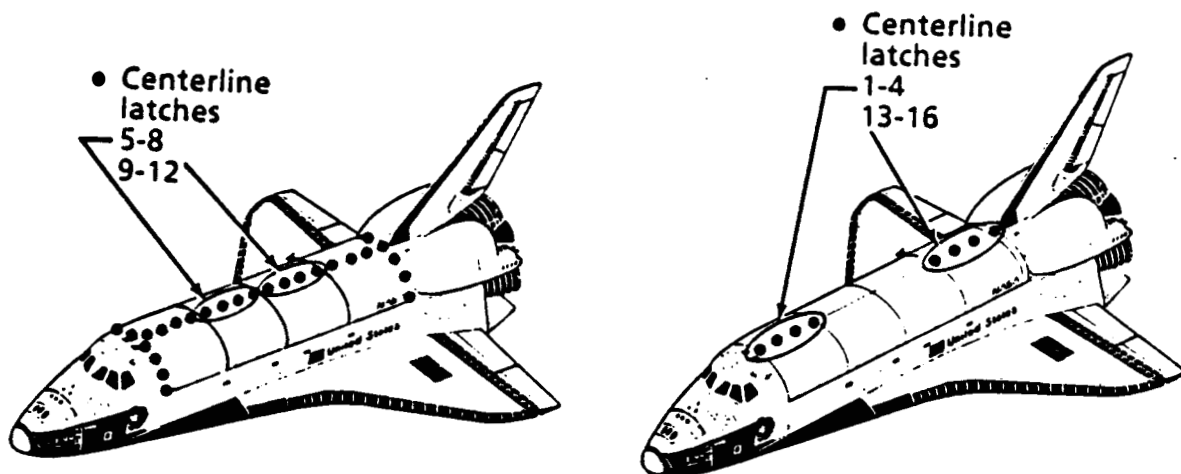
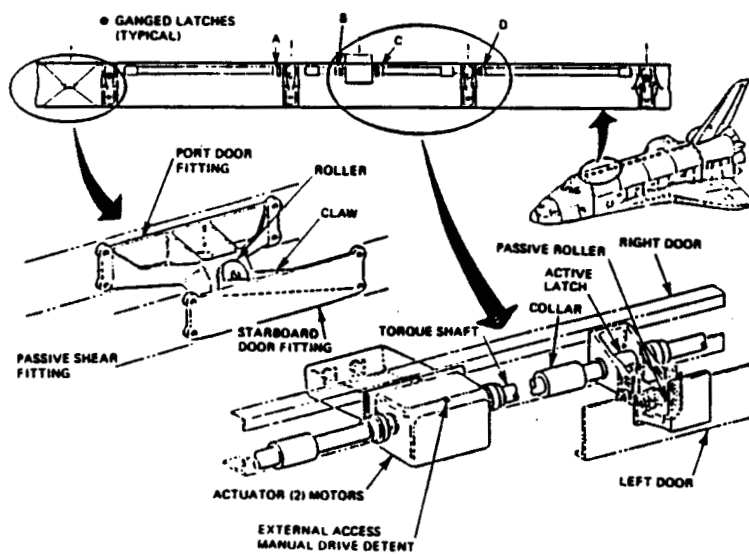

Figure 2.4.2:

PLBD Centerline Latch System



To accommodate thermal expansion/contraction, bending, and twist, the gangs are latched and unlatched in a predetermined sequence. During PLBD opening, latches 5-8 unlatch first, followed by 9-12, then 1-4, and finally 13-16. The middle sets of latches are opened first to relieve the tension in the doors caused by the orbiter's shape change after the last PLBD closing. The forward and aft ganged centerline latches are opened next to relieve the tension on the bulkhead latches also produced by the orbiter's shape change.

The latching sequence for PLBD closure is the opposite of the opening sequence. In the event of the PLBDs being warped, the forward and aft ganged groups can be latched easier than the middle groups because the bulkhead groups will already be latched. After the forward and aft groups are closed, the hooks and rollers of middle gangs will be closer which will make their engagement easier.

2.4.1 Ganged Groups

A ganged group of latches is actually a sub-mechanism which acts with similar sub-mechanisms to accomplish a common goal. In the case of the centerline latch ganged groups, the common goal is to latch the left and right PLBDs together. Each gang holds the forward four opposing PLBD panels together. The fifth panel is held together strictly by the aft bulkhead latches and the shear pins connecting it to the forth panel and has no centerline latch mechanism.

The four centerline gangs are very similar in make-up. They have the same parts and work in the same fashion, but the orientations of the parts vary with the location of the gang (see Figs. 2.4.1.1 and 2.4.1.2). The gang's PDU (with a torque limiter) which is connected to an Inconel 718 torque tube. The torque tube passes through the latch actuator which is connected to the bellcrank. As the bellcrank is turned, the latch hook is mechanically locked around the passive roller.

Figure 2.4.1.1:

Orientations of Ganged Latch Parts

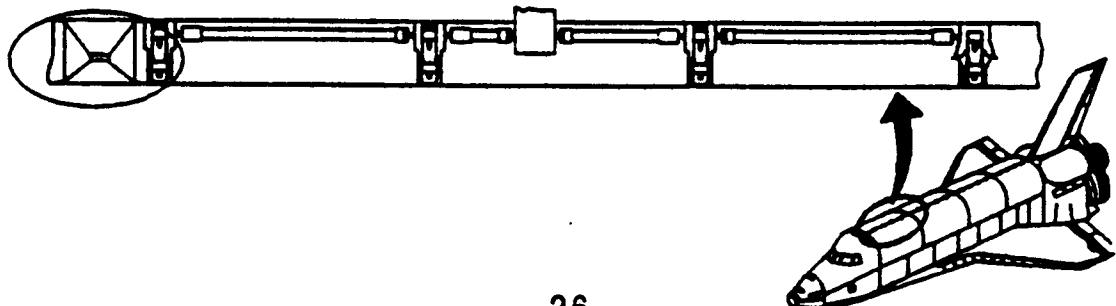
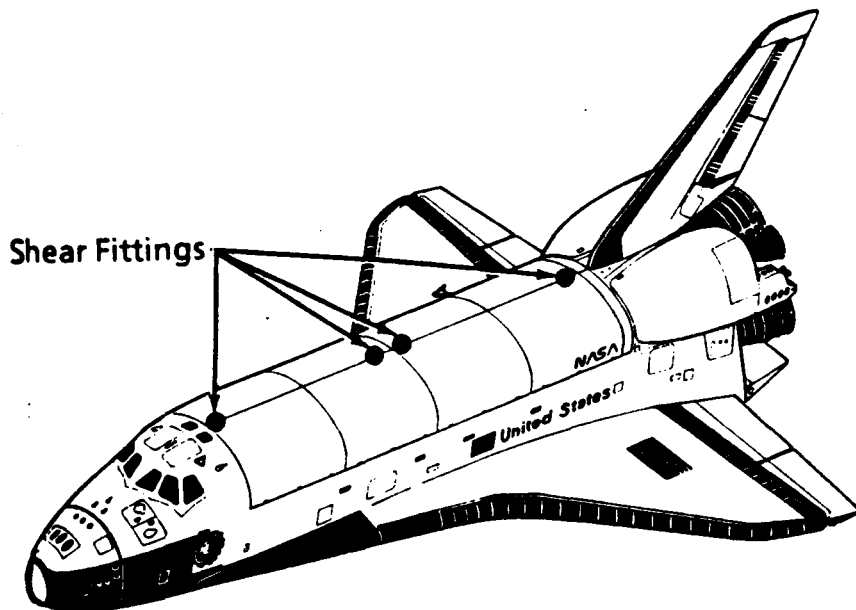

Figure 2.4.1.2:

Locations of Shear Fittings



A locked latch and roller hold the door in the y and z-directions while the passive shear fitting associated each gang holds the PLBDs together in the x-direction, since it controls the shear in that direction. The reasoning behind four gangs is to allow the expansion joints between the PLBD panels to function while the PLBDs are closed and latched.

2.4.2 Power Drive Unit/Torque Limiter

The PDU, like the other mechanisms, has two electromechanical motors for redundancy. These motors are connected together, and also to a torque shaft, through the differential (see Fig. 2.4.2.1). The differential allows the system to be run on only one of the two motors. However, in a single motor mode of operation the latching sequence will take twice as long as a dual motor operation.

In a centerline latch gang, unlike the door drive system, the single torque limiter is positioned inside the PDU (see Figs. 2.4.2.2 and 2.4.2.3). Since the torque limiter is positioned before the torque is transferred to the latch mechanisms, a stall-out in any one gear will stall-out the entire gang. This is because there is not a mechanical linkage which

will allow for translation, or slippage, in the mechanism after the single torque limiter.

Figure 2.4.2.1:

The PDU of the Aft Most Gang on OV-104

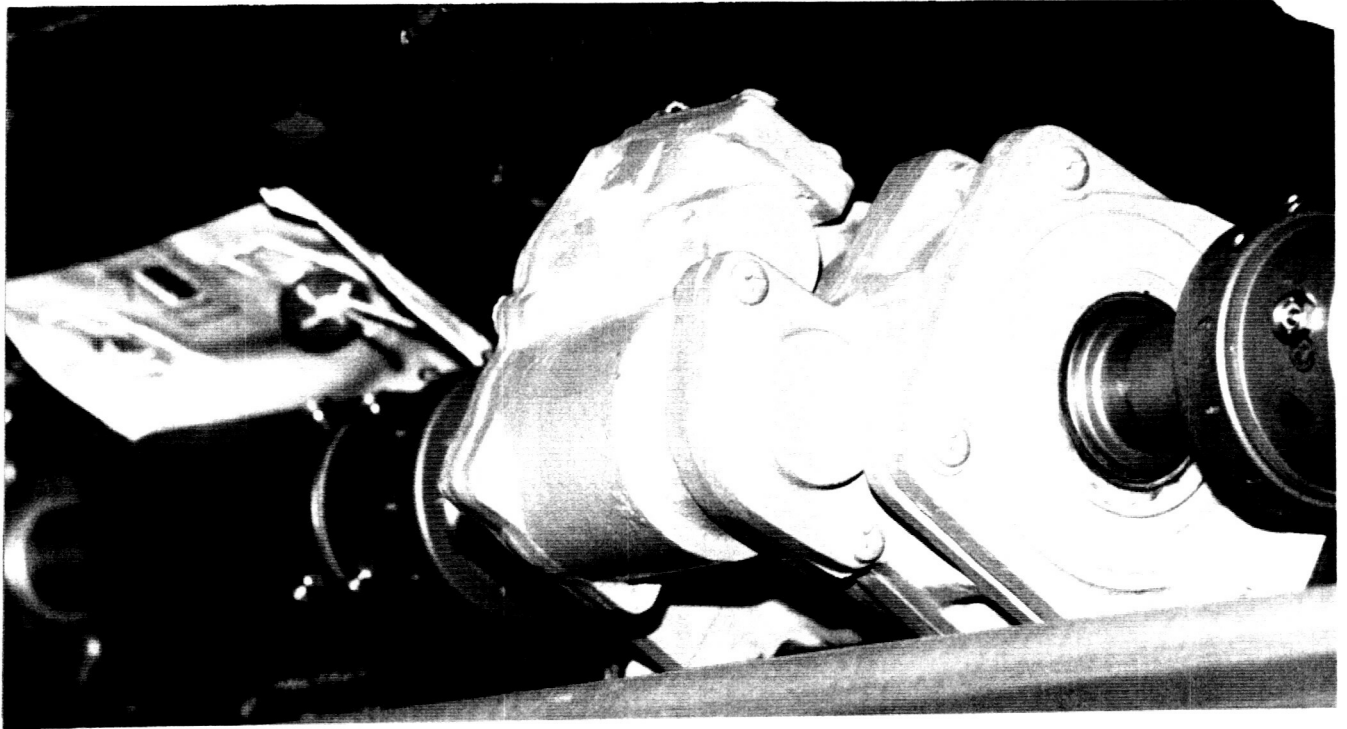

Figure 2.4.2.2:

PLBD Centerline Latch Actuator Schematic

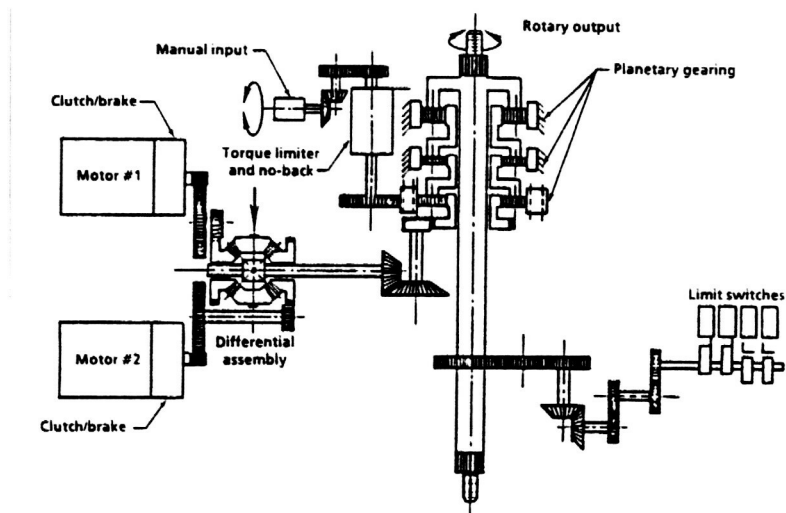
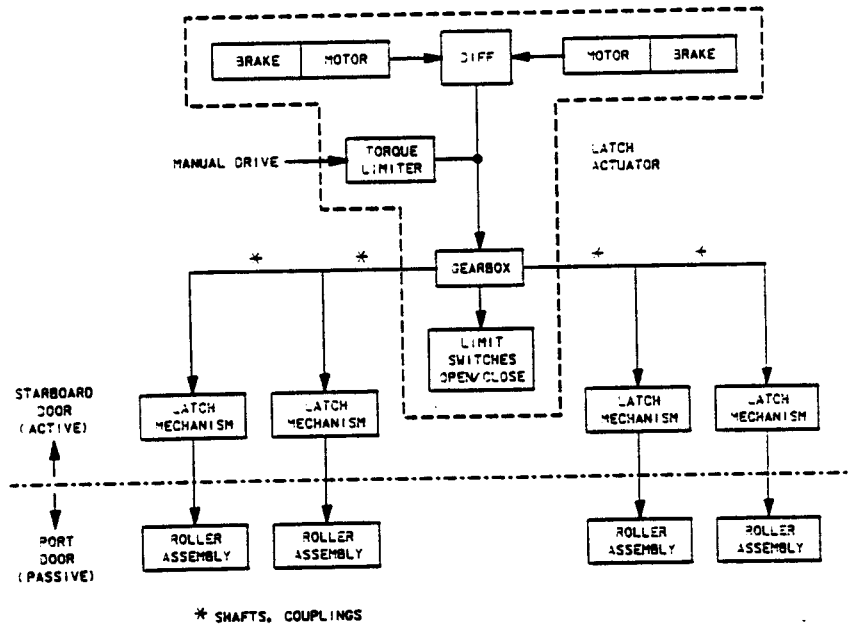

Figure 2.4.2.3:

PLBD Centerline Latch Block Diagram



2.4.3 Passive Shear Fittings

As the doors are driven to a "ready-to-latch" position by the door drive system, a roller on the port door slides into the neck of the claw fitting on the starboard door (see Figs. 2.4.3.1, 2.4.3.2, and 2.4.3.3). The neck has guides at the opening to funnel the roller into its seating area in the claw. This brings the latch hooks and rollers into proper alignment during the latching sequence. Before the centerline latches are driven, the port door fitting is positioned in the larger neck of the claw fitting. The passive shear fittings slide snugly together and become locked which prevents translation of the door in the x-direction during the latching sequence of the gang.

The passive shear fittings are positioned corresponding to the fixed hinges connecting the PLBDs to the orbiter. On panels 1 and 3, the passive shear fittings are located forward of the forward most latch in the gang, while the passive shear fittings on panels 2 and 4 are positioned aft of the aft most latch in the gang. The two fixed constraints (a fixed hinge and a combination of a passive shear fitting and a centerline latch) are positioned at approximately the same X_0

locations. This keeps the plane created by these constraints perpendicular to the PLBDs. This perpendicularity will greatly decrease stresses imposed on the door by expansion/contraction, bending, and twisting.

Figure 2.4.3.1:

Passive Shear Fitting Connection

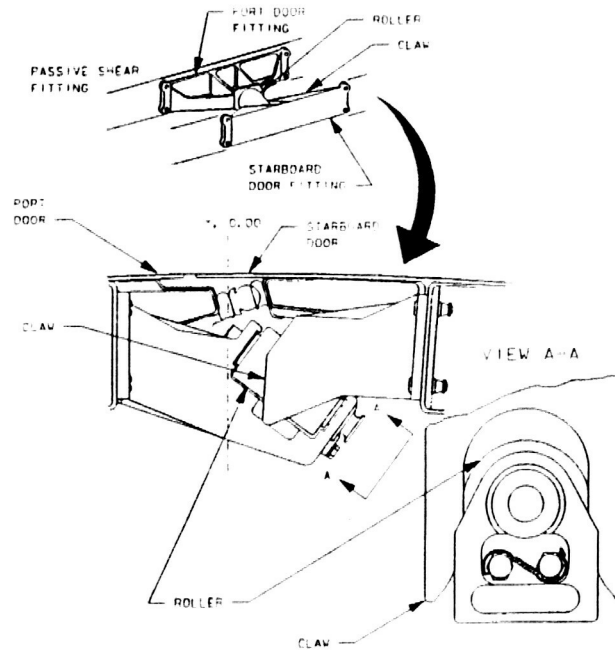

Figure 2.4.3.2:

Port PLBD Passive Shear Fitting

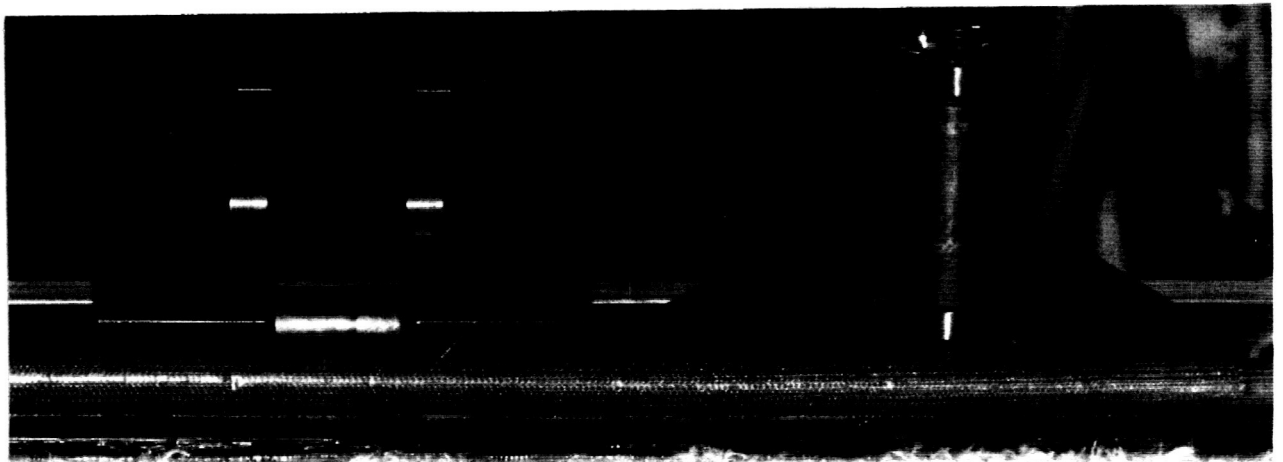
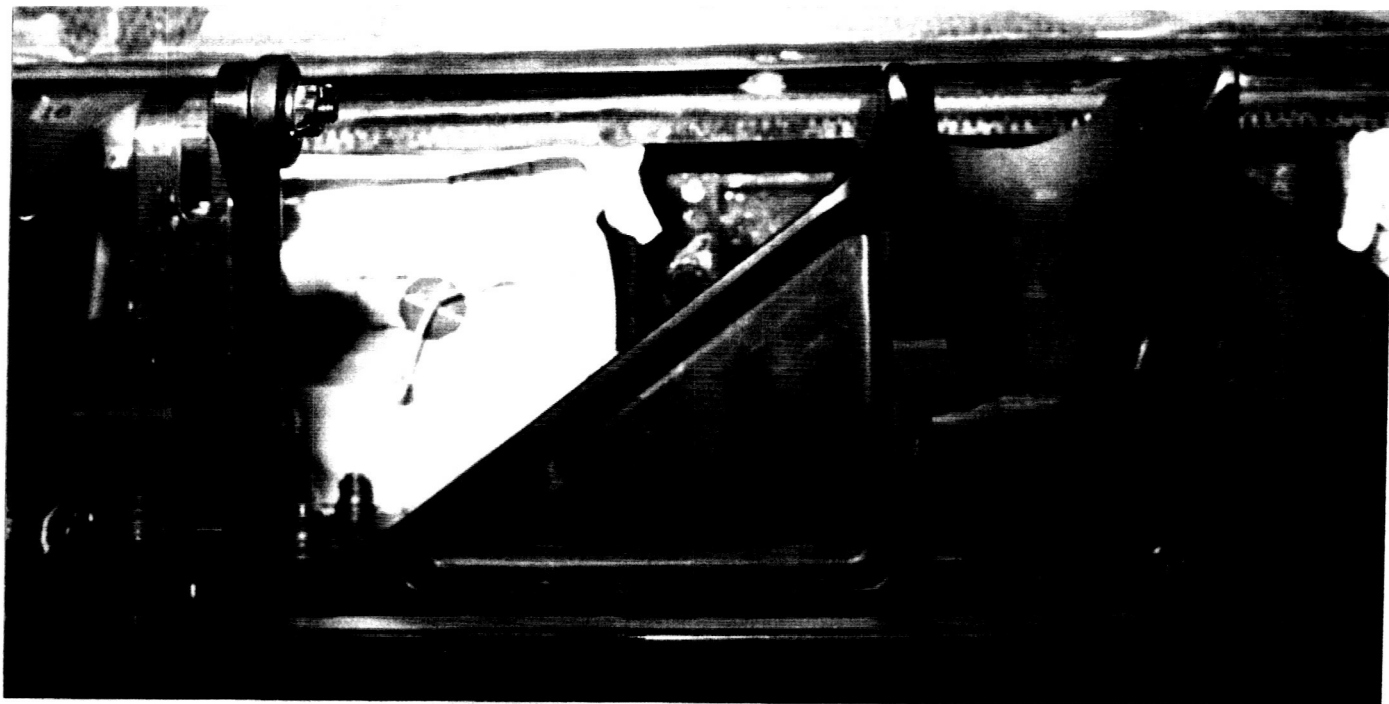

Figure 2.4.3.3:

Starboard PLBD Passive Shear Fitting



2.4.4 Bell Crank and Linkages

The bellcrank is connected directly to the torque shaft, so when a torque is applied to the torque shaft by the PDU the bellcrank is also driven. A single linkage connects the latch hook to the bellcrank. The latch hook is attached to the fixed latch structure at the latch hook pivot point. As the bellcrank is rotated in the closing direction, the linkage pushes the latch hook around the passive roller (see Fig. 2.4.4.1).

In the final latched position, a line drawn between the the centerline of the hook/linkage attach point and the torque tube centerline is "above" the centerline point of the bellcrank/linkage attach point (see Fig. 2.4.4.2). This "over center" functions as a locking mechanism for the latch when in the latched position.

ORIGINAL PAGE
COLOR PHOTOGRAPH

Figure 2.4.4.1:

PLBD Centerline Latch

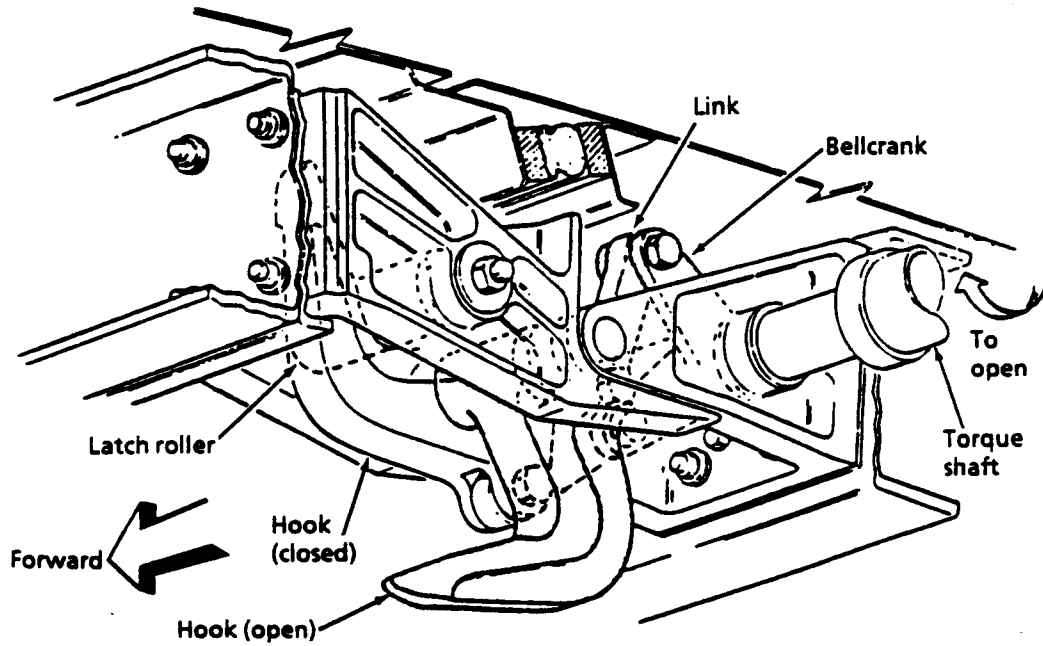
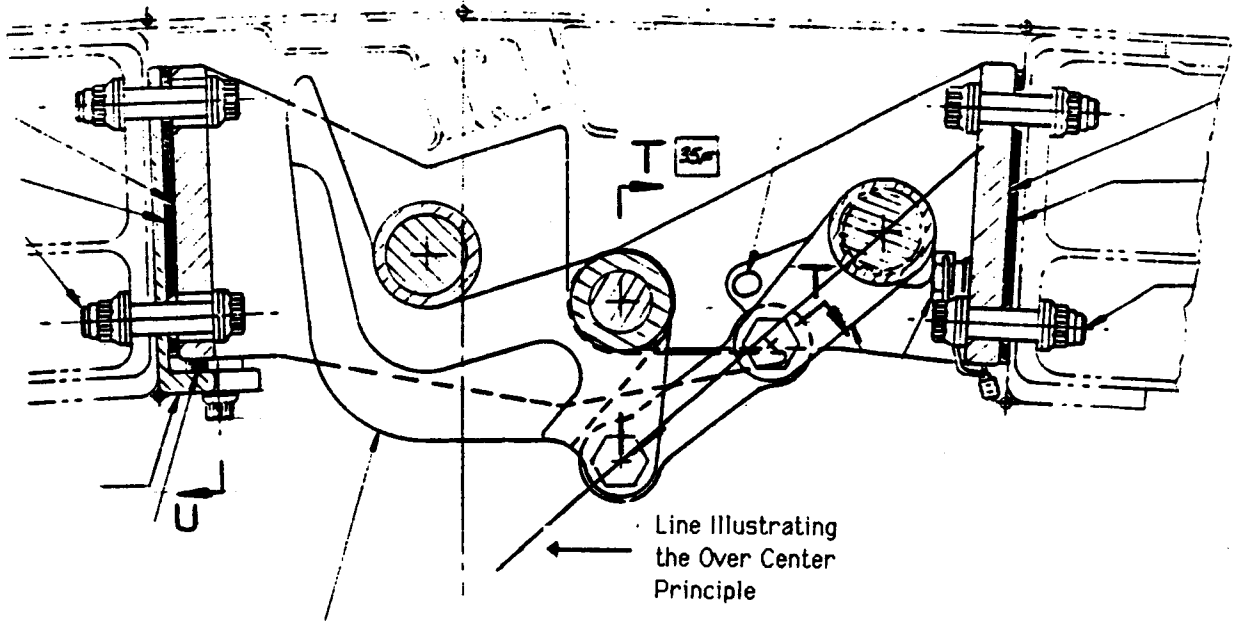

Figure 2.4.4.2:

Offset in the Latch Hook Actuating Mechanism



2.4.5 Latch Hook and Passive Rollers

Two other sets of rollers are being utilized while the latch hook is engaging the passive roller and pulling itself tight against the roller (see Figs. 2.4.5.1 and 2.4.5.2).

One set of rollers is used to make sure the doors do not ride over one another as it is being pulled tight with the latching mechanisms. The latching mechanisms have the ability to pull the doors too close together and cause one door to overlap and ride on top of the other. To prevent this overlap situation from occurring, a backing plate, oriented in the xz-plane, is placed on either side of the latch hook's passive roller. A roller on the starboard door is positioned opposing each plate. The contact between the rollers and the plates prevent the overlap problem from occurring.

The other set of rollers lock the doors in the z-direction while the latches are locking the doors in the y-direction. This set of rollers is positioned between the previously mentioned set of rollers and the latch hook. They make contact with the forks positioned on the port PLBD outside of the latch hook passive rollers. The latch hook mechanism engages the x-direction lockdown rollers by pulling the rollers down tight onto the forks.

Figure 2.4.5.1:

Fork and Backing Plate Rollers

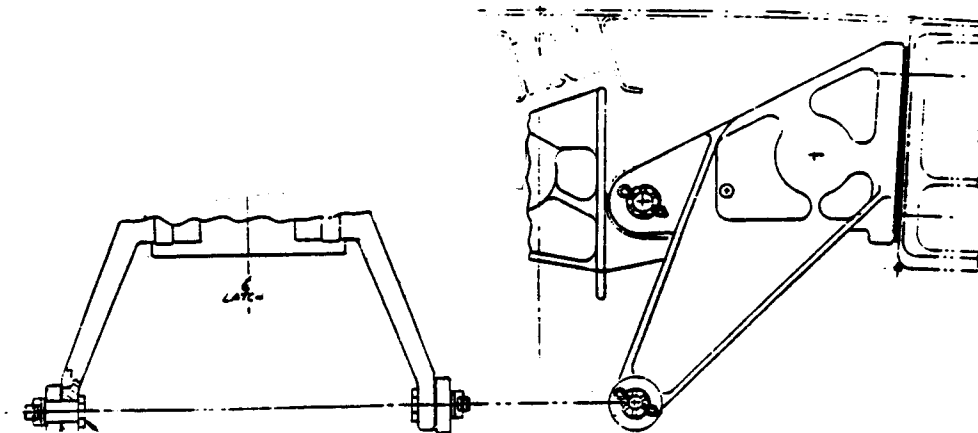

Figure 2.4.5.2:

Centerline Latch Hook Number 16 on OV-104

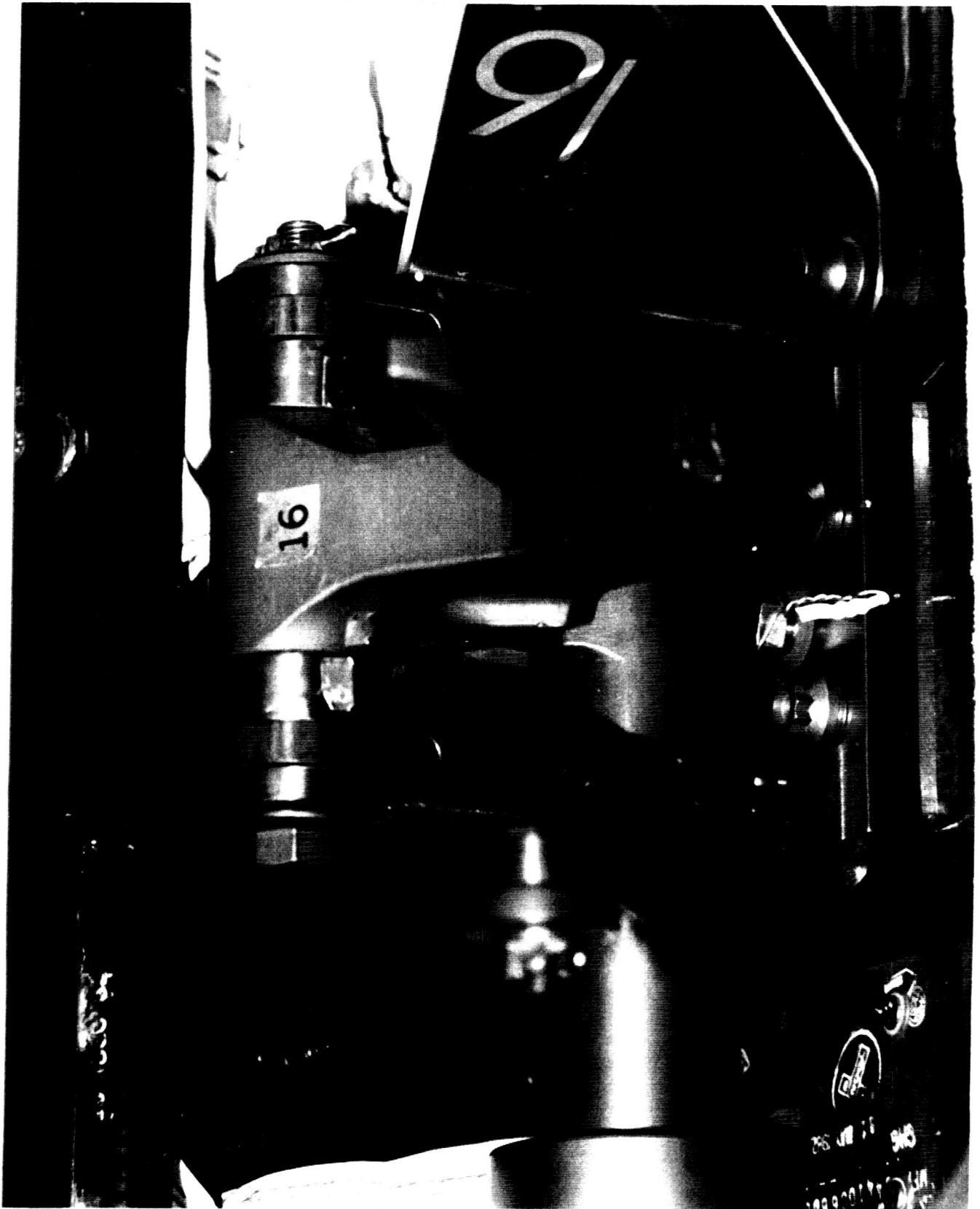
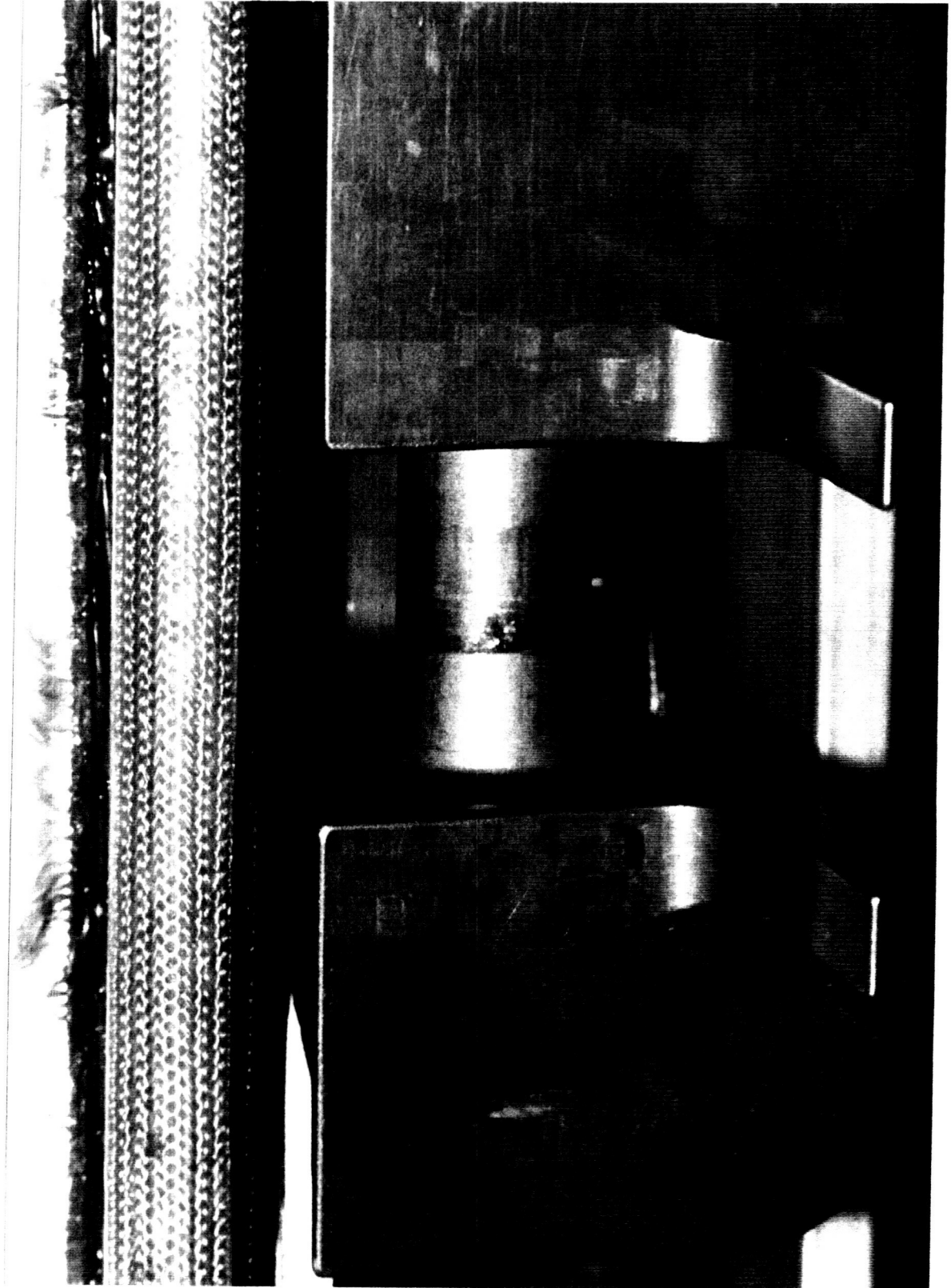

Figure 2.4.5.3:

**Latch Hook Roller on OV-104 with
Forks and Backing Plates**



2.4.6 Latched/Unlatched Limit Switches

The centerline limit switches associated with each gang relay the status of the latch group. The switch box consists of four limit switches (28 VDC); two open and two closed switches. These switches relay the open or closed position indications and also provide an enabling or disabling feature for the mechanism to use. The latter use is discussed in Chapter 4.1.

2.5 FORWARD AND AFT BULKHEAD MECHANISMS

2.5.1 Ganged Groups

The forward and aft bulkhead mechanisms, like the centerline mechanisms, are grouped in four gangs. Each door has a gang at the forward and aft bulkheads (see Fig. 2.5.1.1). The gangs all have a PDU (containing two reversible three-phase electric motors), a torque limiter, four bellcranks, four latches, and four roller assemblies (see Figs. 2.5.1.2 and 2.5.1.3). The power driven mechanisms are located on the forward and aft ends of the two doors (see Fig. 2.5.1.4), while the rollers are located on the bulkheads themselves. The forward and aft gangs are very similar, except, the aft bulkhead gangs also have fore/aft alignment rollers.

Latches are numbered 1 through 4 starting with the latches located closest to the door longeron. The drive system of the gangs is rigged so a staggered latching sequence is achieved. The latches are latched in ascending order, and unlatched in descending order. With the doors in a ready-to-latch configuration (approximately 4° open), latch 1 has the least amount of translation because it is the closest latch to the door hinge line. Latching latch 1 first, decreases the door angle and makes the other three latches easier to close. This logic works with the rest of the latching sequence, and is reversed for the unlatching procedure.

Figure 2.5.1.1:

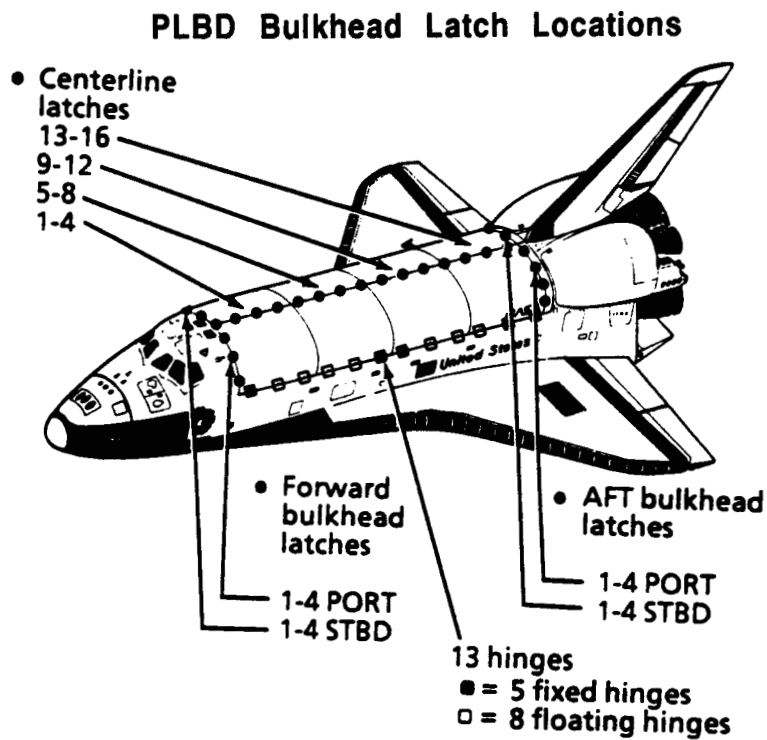

Figure 2.5.1.2:

PLBD Bulkhead Latch System Block Diagram

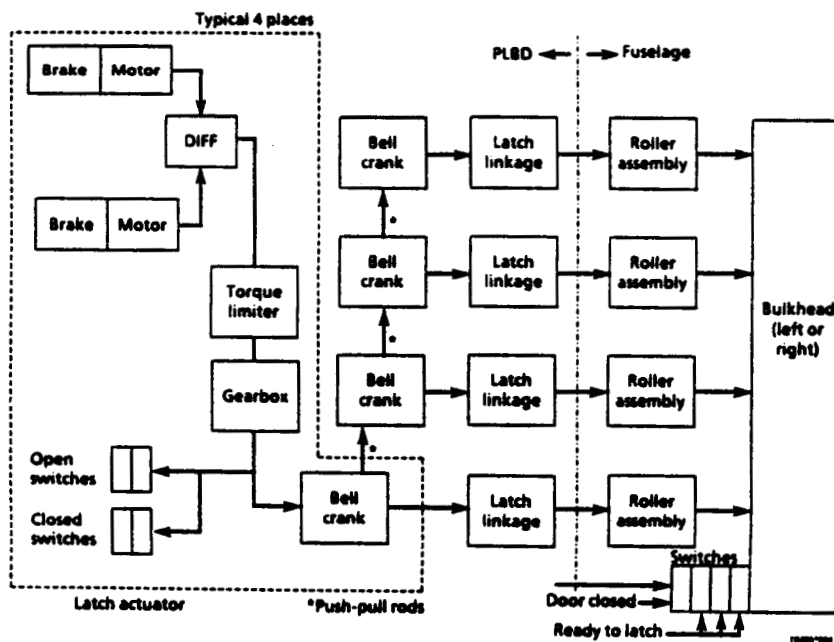

Figure 2.5.1.3:

PLBD Bulkhead Latch Actuator Schematic

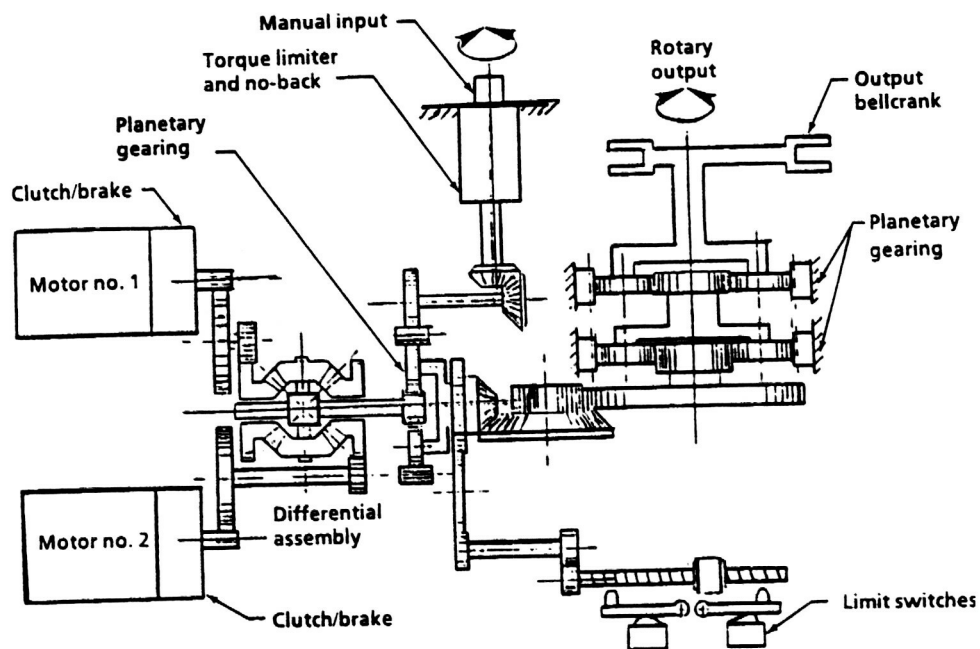
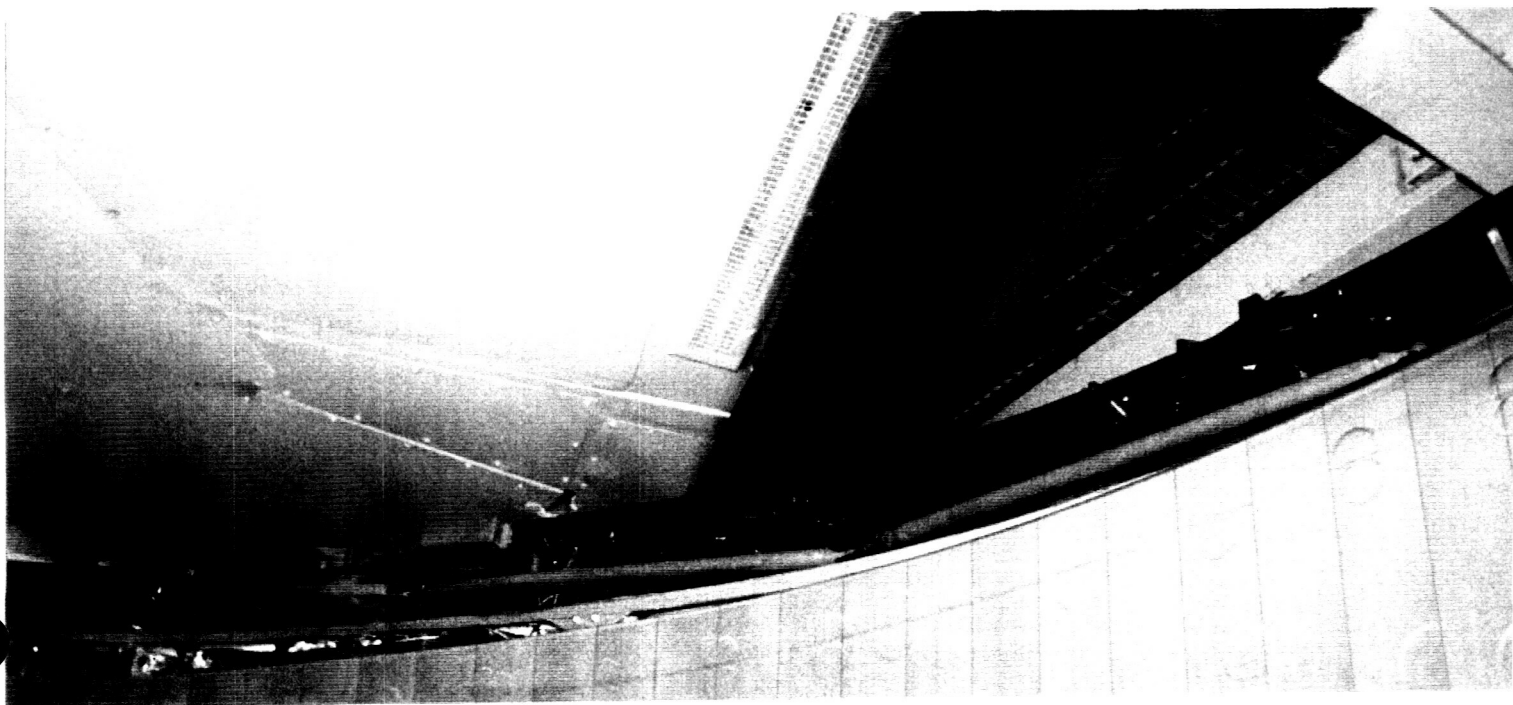

Figure 2.5.1.4:

Starboard Forward Bulkhead Latch Gang on OV-104



2.5.2 Power Drive Units/Actuator/Torque Limiter

The PDU, like the other mechanisms, have two electromechanical motors, for redundancy, which are connected to a torque shaft through a differential (see Fig. 2.5.2.1). The differential allows the system to run on only one motor if one fails, however, the latching takes twice as long as with both motors.

In the centerline latch group, unlike the door drive system, the torque limiter is first positioned before the torque shaft can drive the parallel latch mechanisms. Thus, a stall-out in any one gear will stall-out the entire gang. This is because there is no mechanical linkage which will allow for translation in the mechanism after the torque limiter.

Figure 2.5.2.1:

Starboard Aft Bulkhead PDU on OV-104

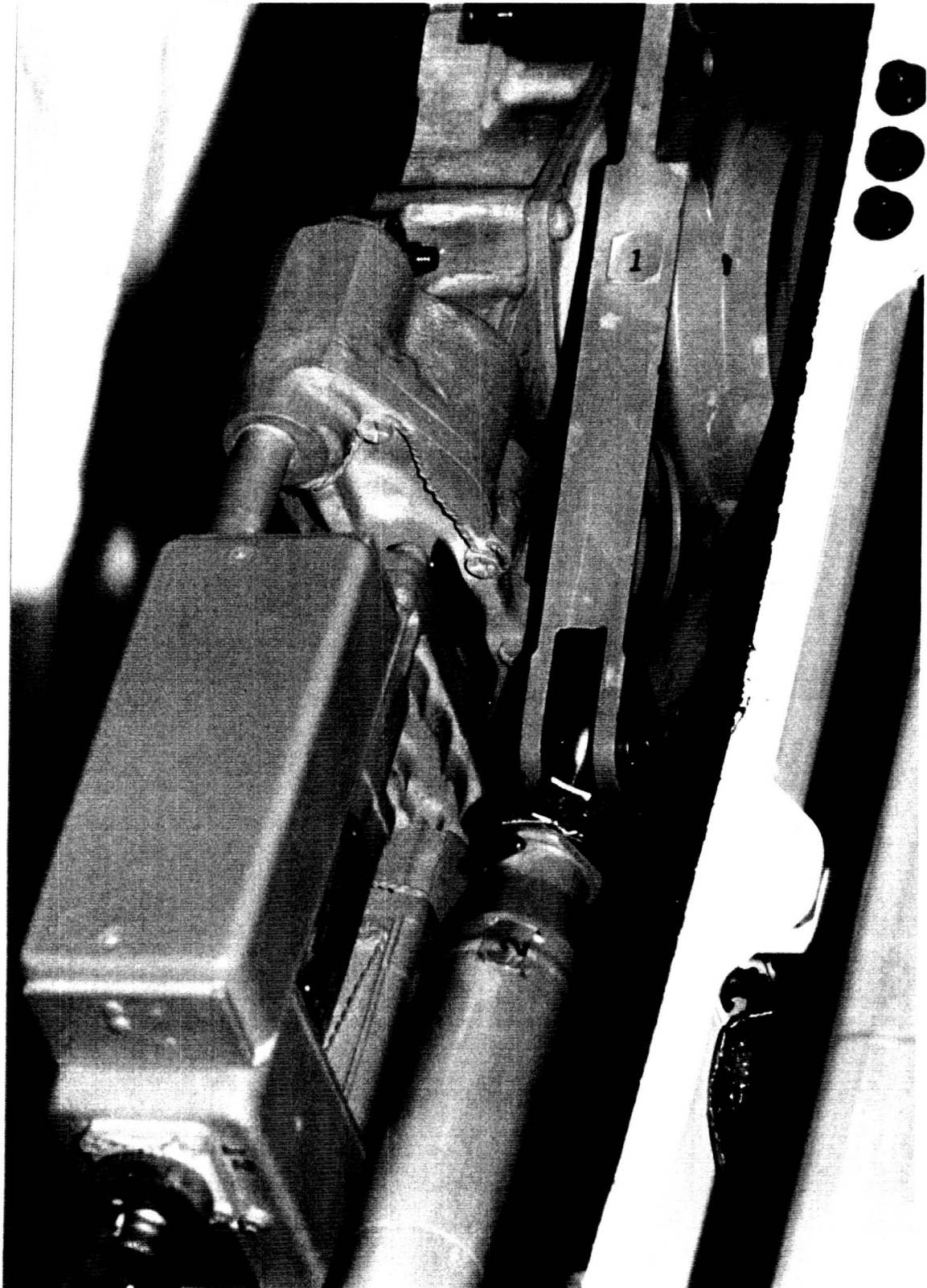

2.5.3 Torque Shaft and Latching Sequence

The torque shaft is connected to the parallel motors in the PDU through the differential. A single torque limiter inside the PDU is inline with the torque shaft to ensure the life of the motors during a failure. The torque shaft and actuators have been rigged in order to stagger the latching sequence which allows the latches to be latched and unlatched in ascending and descending order, respectively. The staggering allows the closing latches to help the remaining latches move into the range of engagement of the rollers.

2.5.4 Latch Hooks and Rollers

The latch hooks rotate from an open position, engage the roller (see Fig. 2.5.4.1), and pull on the roller in order to sandwich it between the latch arm and a scalloped mating surface (see Fig. 2.5.4.2). The latch arm actually pulls the door closed by applying a force to the roller. As the door is being pulled to the roller and the roller has made contact with the scalloped portion of the latch, the door is being aligned with the help of the roller. The staggered latch sequence is a necessity because the roller must be within the reach of the latch arm. The reach of the latches varies with latch number and between bulkheads. Table 2.5.4.1 gives the maximum reach for each latch location.

Figure 2.5.4.1:

Forward Bulkhead Attachment Roller

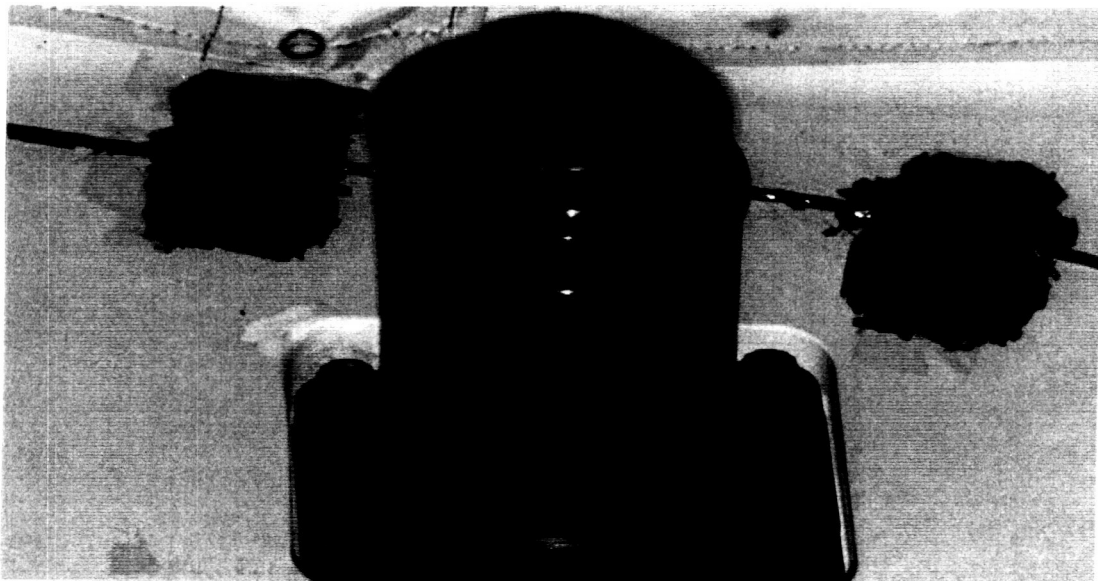

Figure 2.5.4.2:

Aft Bulkhead Latch and Scallop

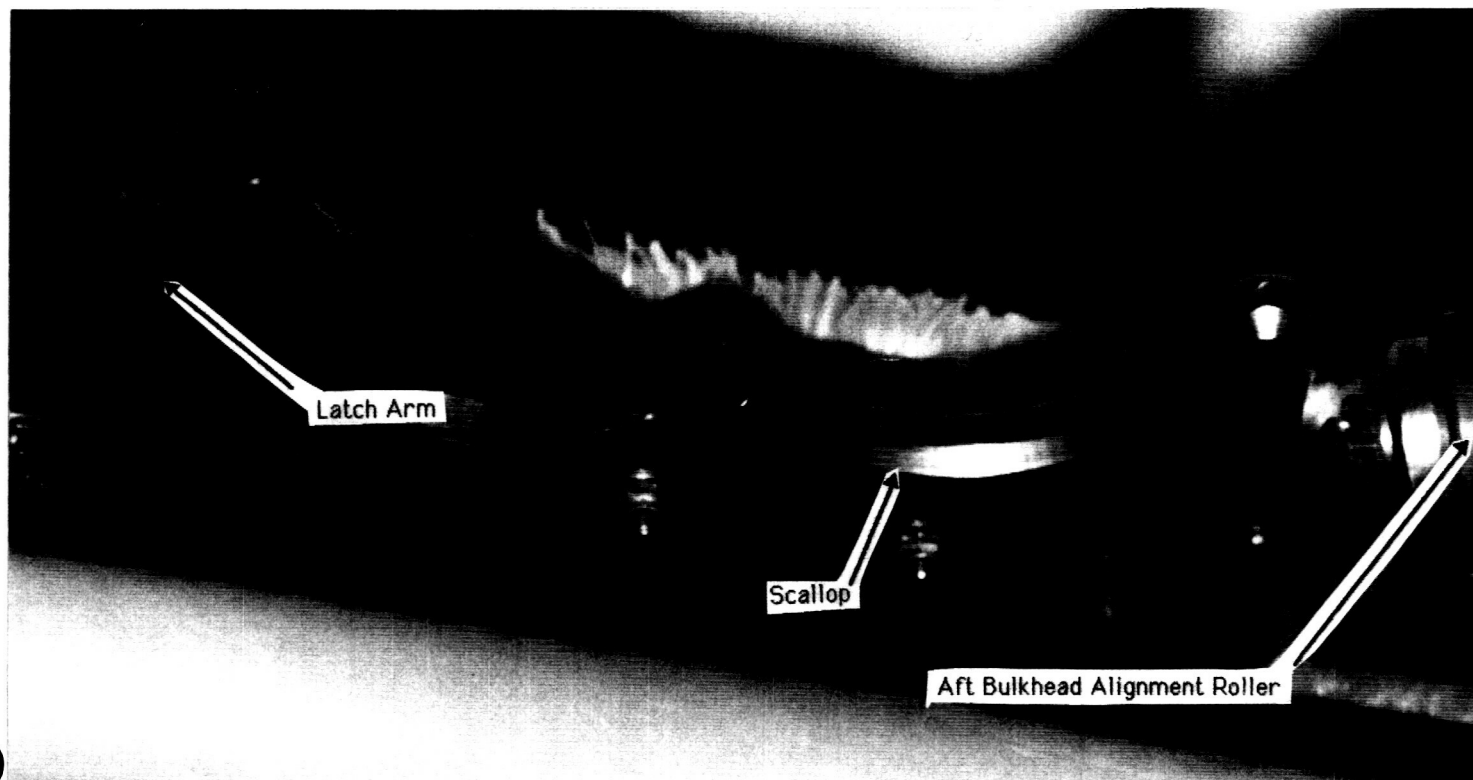

Table 2.5.4.1:

**Maximum Reach for Latch Locations
in Inches**

Latch Number	Forward Bulkhead	Aft Bulkhead
1	2.000	2.000
2	2.000	2.000
3	1.333	1.212
4	1.428	1.333

2.5.5 Fore/Aft Alignment Rollers

Each aft bulkhead roller has an accompanying hook positioned outboard from the roller (see Fig. 2.5.5.1). They are oriented at different angles depending on the latch position. These hooks guide rollers,

attached to the PLBDs (see Fig. 2.5.5.2), to set X_0 locations and hold them fixed at that location. With locations set and held fixed, the forward bulkhead latches can be latched with the assumption that the rollers and accompanying latches will be properly aligned. After the forward bulkhead latches have been latched, friction in the x-direction between the latch, roller, and scalloped section holds the X_0 location of the forward end of the PLBDs fixed. With both ends fixed, all translation in the PLBDs due to thermal expansion/contraction, bending, and twisting will be "absorbed" by the expansion joints.

Figure 2.5.5.1:

Aft Bulkhead Attachment Roller and Alignment Hook



Figure 2.5.5.2:

**Aft Bulkhead Alignment Roller
and Latch Mechanism**

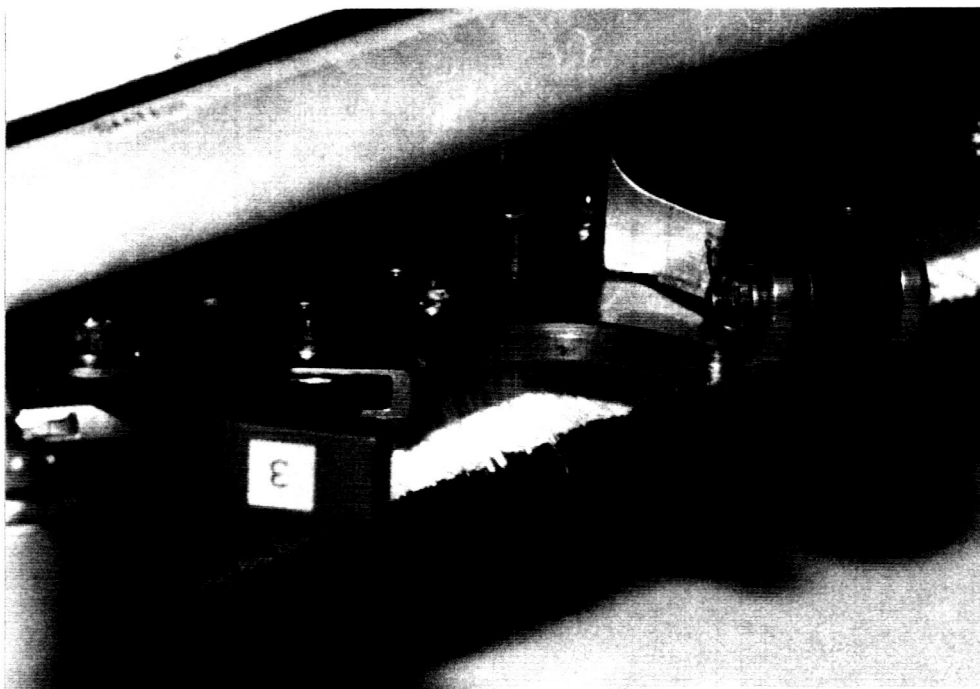

2.6 PRESSURE AND CONTAMINATION CONTROL SEALS

A major responsibility of the PLBDs is to protect the Payload Bay and the payload from danger. Since the Payload Bay has a cleanroom environment, this danger includes contamination. Contamination concerns range from floating dust particles to water introduced by condensation and/or rain. If contamination control barriers breakdown, payloads may be effected with subsequent reduced mission success.

2.6.1 Bulb Seals and Seal Depressors

The bulb seal system physically seals the gaps located at the centerline, the forward and aft bulkheads, and the hingeline. This barrier is critical for contamination control and is able to withstand delta pressures and temperatures.

The bulb seal system consists of two pieces; the bulb seal and the seal depressor (see Figs. 2.6.1.1 and 2.6.1.2). The seal depressor pushes on the bulb seal while the doors are latched.

The bulb seal has a TFE (Tetrafluoroethelene), or Teflon, outer shell which surrounds a CRES (Corrosion Resistant Steel) spring

material (see Fig. 2.6.1.1). The TFE gives the seal toughness and flexibility, while the CRES gives it rigidity. "Feet" are bonded to the bulb seal with RTV to provide an attach point to grooved runners on the orbiter.

The seal depressor is a Gr/Ep (Graphite Epoxy) structure which applies a force to and depresses the bulb seal (see Fig. 2.6.1.2). A pressure, temperature, and contamination control barrier has been established when forceful contact is made between the seal depressor and the bulb seal.

Figure 2.6.1.1:

Port PLBD Contamination Control Systems

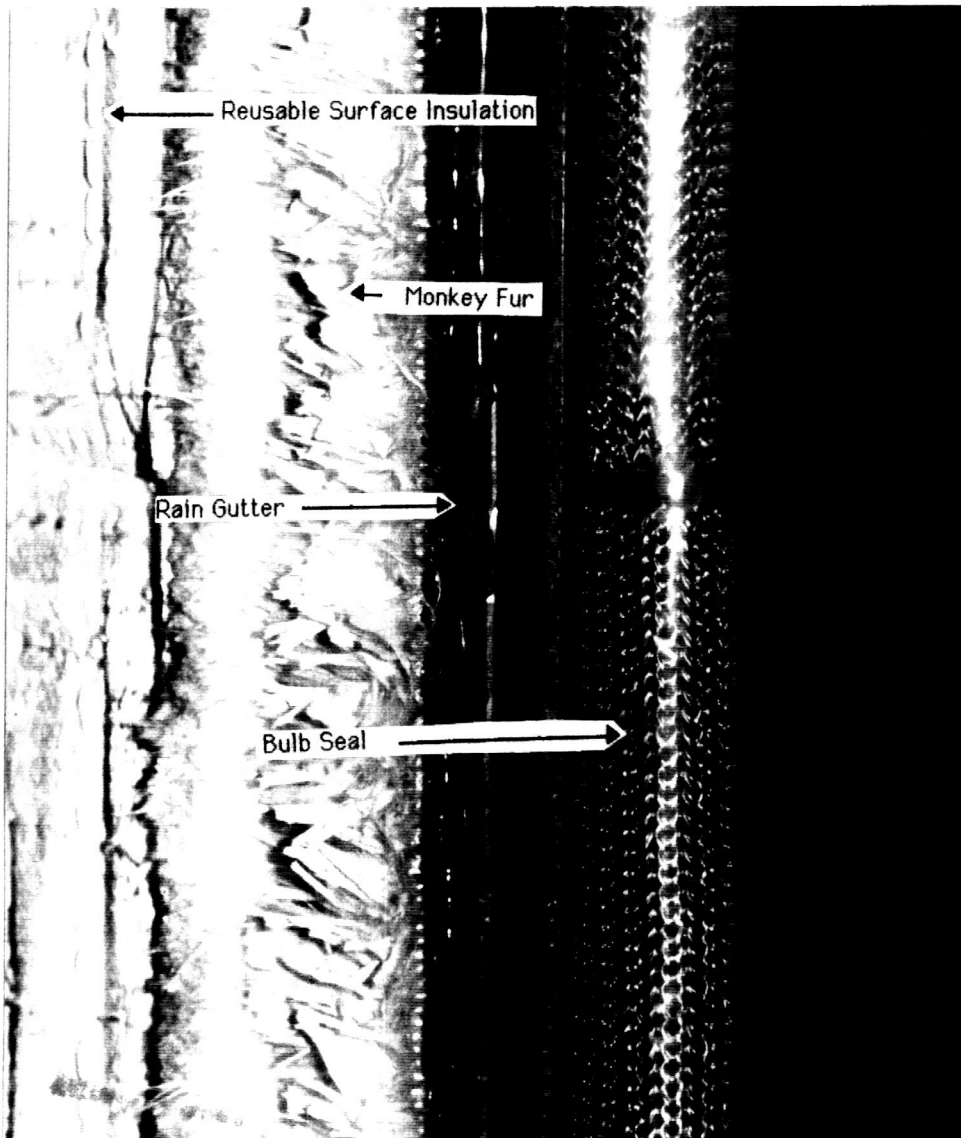
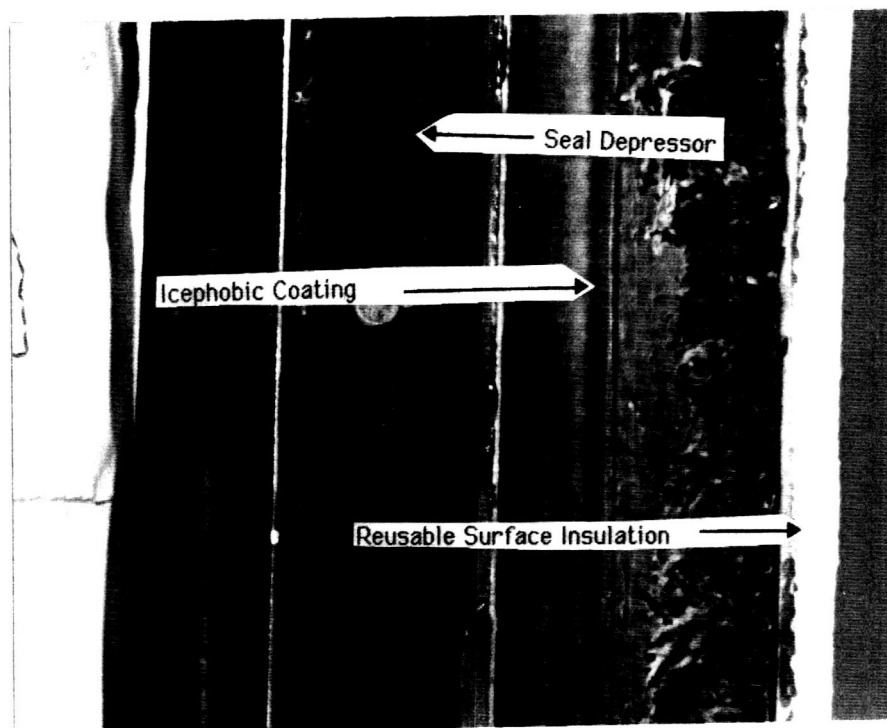

Figure 2.6.1.2:

Starboard PLBD Contamination Control Systems



2.6.2 Contamination Control System

The first line of defense against contamination is a barrier formed by bringing S-glass (fiberglass) fibers (see Fig. 2.6.1.1) in contact with an icephobic coating (see Fig. 2.6.1.2). The S-glass and icephobic coating are respectively termed "monkey fur" and "monkey fur grease."

Water diversion is a big concern because the Space Shuttle is exposed to a hostile Florida environment for over a month while at the pad. Rain and condensation are frequent occurrences in Florida and not a drop of this water should be seen in the Payload Bay or the PCR (Payload Changeout Room). As a backup to the monkey fur system, a rain gutter has been added as a modification to the orbiters to divert water away from the payload bay. The rain gutter, positioned between the monkey fur and the bulb seal on the port PLBD, runs the length of the PLBD. Water, which is trapped by the rain gutter, is diverted away from the payload bay by plastic tubing which channels the water out of the orbiter.

2.6.3 Orientations of the PLBD Protective Barriers

The payload bay is protected from contamination by the bulb seal and monkey fur systems.

Figs. 2.6.1.1 and 2.6.1.2 are photographs of the bulb seal-monkey fur configurations control systems on the port and starboard PLBDs. The seal depressor and icephobic coating are on the starboard PLBD while their sealing counterparts, a bulbseal and monkey fur, are attached to the port door. Icephobic coating is on a flange that overlaps the monkey fur on the starboard PLBD.

The two hingeline interfaces are sealed utilizing a different configuration than the centerline. Here, the bulb seal and the monkey fur are attached to the midbody while the seal depressor and the icephobic coating are on the PLBDs. The seal depressor is not exactly like that of Fig. 2.6.1.2; however, it performs in a similar manner.

The fore and aft bulkhead sealing interfaces vary in configuration. They both utilize a bulb seal and seal depressor attached to the midbody and PLBDs, respectively. The forward bulkhead uses monkey fur attached to the midbody and icephobic coating on a flange which overlaps the bulkhead. The aft bulkhead is covered with icephobic coating. Monkey fur is attached to the aft end of the PLBDs in order to form a seal with the aft bulkhead.

2.7 DOOR OPENING AND CLOSING OPERATIONS

2.7.1 Horizontal PLBD Structural Supports and Aids

The PLBDs are not designed to hold their own weight in an unlatched horizontal configuration. The layup for the curved composite structure is designed to support the loads encountered in flight configurations and not those encountered during orbiter processing. Support fixtures are attached to the doors to provide the needed forces or torques to keep the doors from deforming in one way or another during horizontal ground processing.

The two flight configurations which the doors encounter during flight are closed in a latched configuration and open in zero gravity. The first flight conditions encountered in zero "g" as well as one "g." The second is only encountered in space. A zero "g" apparatus must be used to test the system in a one "g" environment under zero "g" conditions.

2.7.1.1 Strongback Supports

The strongbacks (not to be confused with the torque tubes used in the vertical) are used to supply stiffness and rigidity to open doors, to uniformly apply the forces from zero "g" apparatus and floor jack to the doors, and to install or remove a set of PLBD panels. The strongbacks must be used to allow the PLBDs to support their own weight. The four strongbacks support the first two and the last three PLBD panels on both the port and starboard sides of the orbiter (see Fig. 2.7.1.1.1).

The strongbacks have proven to be a necessity in order for the doors to have the rigidity and strength to support their own weight, especially in the closed and unlatched position with the zero "g" fixture unattached. During the construction of OV-99, the first two and last three panels were installed using the strongbacks as handling fixtures. When it got to KSC, the strongbacks were reattached and utilized as support fixtures for the doors' weight and an attachment fixture for the zero "g" apparatus. The process of applying continuous weightlessness to the doors through the zero "g" apparatus, required continuous utilization of the bridge buckets. It was decided to support the door segments with the door longerons and the bulkheads and unattach the zero "g" apparatus from the strongback. This released the bridge buckets and allowed them to be utilized elsewhere. After doing so, it was noticed that the door began to significantly sag in the area unsupported by the strongback on the side of the door section farthest from the bulkhead. After the first occurrence of the sag, it became common practice to support the area with a GSE jack.

Figure 2.7.1.1.1:

**PLBD Strongback Supports with the C-hooks
and Zero "g" Apparatus In Operation**

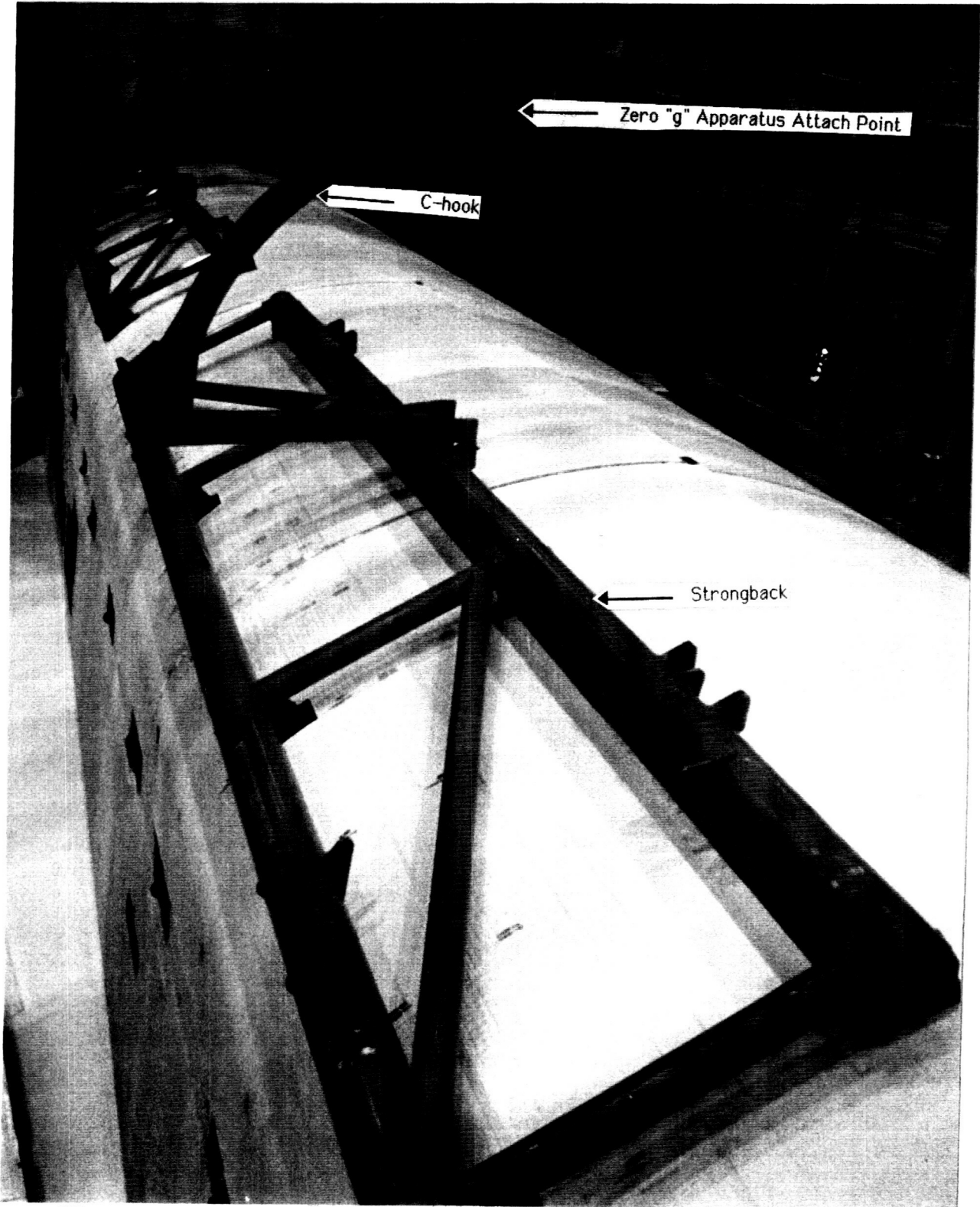

2.7.1.2 Zero "g" Apparatus and Weight Basket

The door drive system is designed with the torque to open and close the PLBDs in the weightlessness of space. For the door drive system to be tested on earth, the zero "g" apparatus is used to simulate weightlessness. The zero "g" system simulates weightlessness by applying a force equal to the weight of the doors (and the attached GSE fixtures) in the opposite direction of gravity. This force is applied to a C-hook which connects to the strongback near the cg (center of gravity) of the door.

One zero "g" apparatus is connected to each of the four strongbacks (see Fig. 2.7.1.1.1). The system consists of steel plates, a weight basket, cable, pulleys, and a C-hook. The steel plates (weighing the same as the door segment, the strongback, the C-hook, the radiator panels, freon in the radiators, and etc.) are placed in weight baskets. The weight baskets are then connected to a cable which runs over two pulleys on the bridge bucket support beam and connects to the C-hook. The two pulleys rotate the downward force created by gravity on the weight basket into a force acting upward on the PLBDs. This upward force is what puts the doors in equilibrium, or close enough to equilibrium for the door drive system not to stall-out. The doors are rotated in the OPF to approximately 145° to allow enough space for the T-O umbilicals, the wing, and the orbiter sidewalls (door 44) to be accessible.

The weight and cg of the door can never be calculated exactly; however, the torque limiter gives some leeway to the calculation. There are two ways the torque limiter can stall-out the door drive system. When the doors are in the closing operation the door drive system can stall-out if there is too much weight in the weight basket. If the torque limiter slips and stalls the drive system out in this case, weight needs to be taken out of the weight basket. In the reverse situation, a opening operation can stall-out because of not enough weight in the basket. This second problem is solved by simply adding more weight to the weight basket. When changes are made to the weight baskets during a flow in the OPF, the baskets are left configured with the weight changes until weight is added or taken away from the door segments or another stall-out occurs.

2.7.1.3 Payload Bay Door Floor Jack

To free up the bridge buckets, the zero "g" apparatus is used only for opening and closing operations. A floor jack is attached to the strongback to support the PLBDs during normal everyday operations. This does not provide for simulated weightlessness, but it does hold the door segment at a fixed angular orientation. Weightlessness is only needed for driving the doors open or closed, so the floor jack is all that is needed to support the door when the door drive system is not being utilized.

2.7.2 Vertical PLBD - Torque Tubes

Once again, the PLBDs are not designed to support their own weight. In the vertical orbiter orientation, the doors will deform if a support structure is not placed on the doors before they are unlatched and opened. This deformation does not make a skewed parallelogram out of the doors, in fact the doors, in theory, do not translate in the negative X-direction at all. The deformation is a warping of the doors which might prevent latching if it is allowed to occur. The PLBDs' weight and curvature produce a torque on each door while open in the vertical position. The curvature, or warping, consists of bending the forward most end in and the aft most end out.

Torque tubes are installed on each segment of both doors (see Fig. 2.7.2.1) to counteract the warping on the forward and the aft parts of the doors. The forward arm of the torque tube can be preloaded to a needed torque by turning a set screw to a calibrated distance A (see Fig. 2.7.2.2 and Table 2.7.2.1). The needed torque varies between PLBD segments due to the different weight, and therefore warping, of each segments. The torque applied to the forward most arm of each torque tube pulls the centerline of the forward part of the segment out and pushes the centerline of the aft part of the segment in. The state of equilibrium produced by the torque tubes allows the PLBDs to remain unwarped and the latches to remain within latching distances.

The door drive system works without any structural or mechanical aid when the Space Shuttle is in the vertical position because the door drive system does not have to overcome the torque created by the weight of the door. The door drive system can possibly be stalled-out in the vertical position by a delta pressure against the inside and outside surfaces of the PLBDs and/or abnormal friction in the door hinges; however, these situations are quite rare.

Figure 2.7.2.1:

**Torque Tubes Attached to the Orbiter
in the Vertical Position**

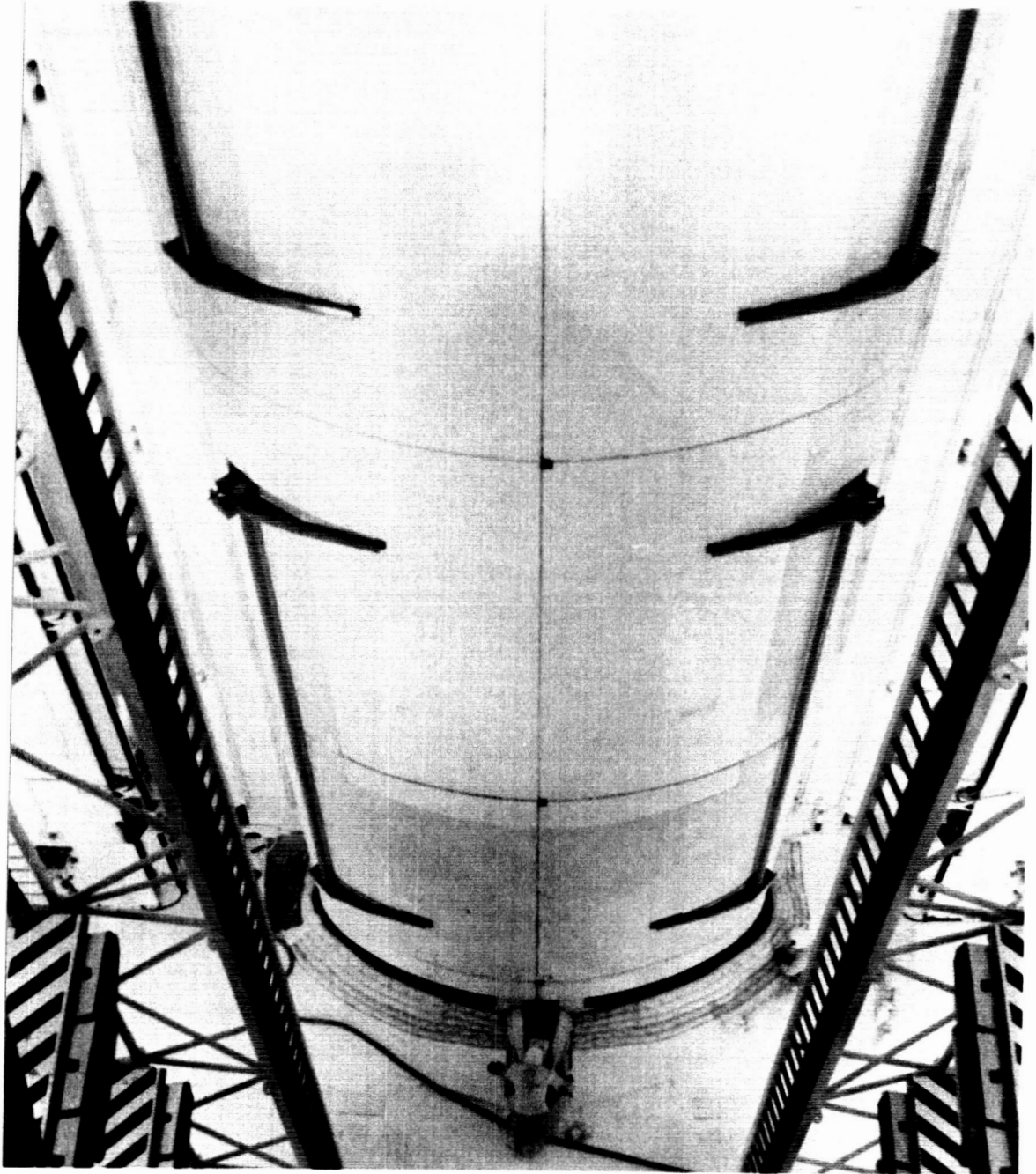

Figure 2.7.2.2:

Torque Tube and Preloading Set Screw Interface

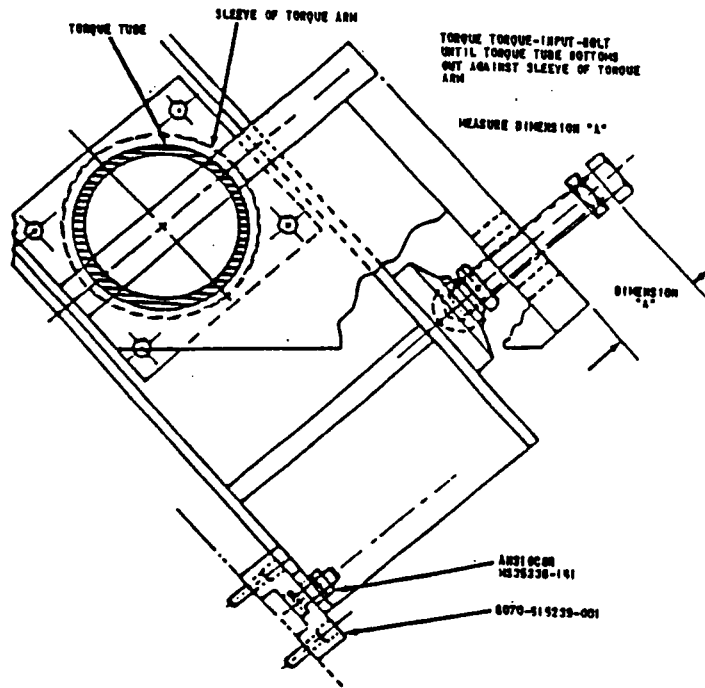

Table 2.7.2.1:

Set Screw Dimension A for Torque Tube Preloading

Torque Tube	Dimension A
Right-hand Lower	0.37 in.
Left-hand Lower	0.34 in.
Right-hand Upper	0.39 in.
Left-hand Upper	0.36 in.

2.7.3 Opening/Closing Procedures

The opening and closing procedures are written in different OMI's (Operation and Maintenance Instructions) to facilitate different conditions. The following list shows all the OMI's which are used to open and close the doors:

V5018	PLBD Final Closing - Horizontal
V5045	PLBD Operations - Pad
V5082	PLBD Opening and Closing (DFRF-CLS)
V9023	PLBD Operations - Pad/OPF (RTOMI)
V9023.001	PLBD Operations in the OPF (RTOMI)
V9023.002	PLBD Operations at the Pad (RTOMI)
V1015	Payload Radiator Mechanical Checkout
V5006	PLBD and Latch Functional Checkout

V9023.001 and .002 are under review to decrease the number of books used to perform PLBD operations. V9023.001 will replace V9023 and possibly V5018, while V9023.002 becomes the only PLBD operations book at the pad, by replacing V9023 and V5045.

2.7.3 On Orbit

2.7.3.1 Structural Aids

No special structural supports are required for the PLBDs during the mission. The doors are structurally designed to be opened and closed in the weightlessness of space and during a mission, the doors are opened and closed exclusively in space.

The door drive system does not have to overcome a moment created by the mass of the door and gravity. The only thing the door has to overcome is the door's moment of inertia in a resting position and friction in the hinges and mechanisms.

2.7.3.2 Opening/Closing Procedures

The opening/closing requirements on the PLBDs are focused around the need for the radiation of heat away from the orbiter by the radiator panels. They are deployed within the first few orbits depending on the payload's needs. The doors can be opened or closed in an automatic or

manual mode with the R13 panel in the aft flight desk. In a case where the doors do not open in the first few orbits, the mission will be aborted and the orbiter will return to earth to prevent overheating damage to the computers. If the doors fail to close, the astronauts will perform an EVA by winching the doors down and latching the latches with a torque wrench type of device.

2.8 PLBD ALIGNMENT/ORIENTATION SYSTEMS

2.8.1 Crew Optical Alignment System (COAS)

The crew is able to check the alignment of the centerline by use of the crew optical alignment system (COAS); however, this ability is rarely utilized. This system is primarily used to navigate by the stars, but it can be utilized during the PLBD closure operations. The telescope-like apparatus is mounted on a bracket near the payload bay windows in the aft flight deck. The reticle is able to check the alignment of decals on the centerline latches and therefore verify the alignment of the PLBD centerline.

2.8.2 Push-pull Rod Markings

Push-pull rod markings are silver and gold decals attached to the push-pull rods of the door drive system which indicate the angular orientation of the PLBDs to the crew (see Figs. 2.8.2.1 and 2.8.2.2). The system gives the crew information to determine if the PLBDs are warped or jammed. The crew should visually check to make sure that no silver bands are showing on either of the twelve push-pull rods before the latching sequence is initiated. There are ten stripes on each push-pull rod; however, the tenth stripe (silver) is located underneath the sill and can never be seen by the crew.

Figure 2.8.2.1:

Push-pull Rod Markings on an Actuator Arm

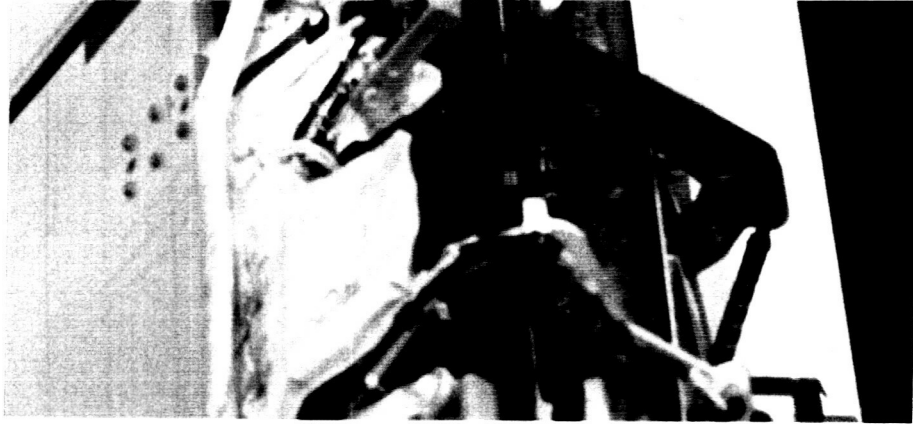
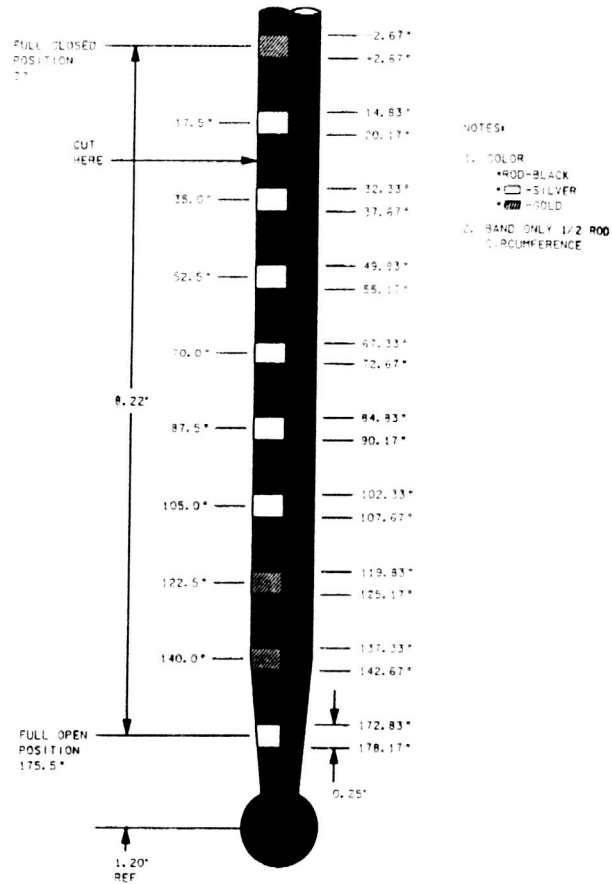

Figure 2.8.2.2:

Push-pull Rod Markings Angular Indications



3. RADIATOR PANELS

3.1 OVERALL STRUCTURE AND PERTINENT DETAILS

The radiator panels allow the orbiter to dissipate heat generated by orbiter heat loads and mission thermal requirements. Heat generated throughout the orbiter's electrical components is transferred to Freon 21, which runs through the midbody and aft-fuselage in two independent loops. Freon 21 flows through the radiators through tubes mounted near the radiator panel skin which provides a high efficiency heat transfer to space.

The radiators of the Space Shuttle are each divided into 4 panels, numbering from forward to aft. The first three radiator panels are connected to the inside of their corresponding door panels. A fourth radiator panel is kitted and fixed to the two aft door panels (Panels 4 and 5). The geometry of the left and right-hand panels are identical, except for notches cut into the right-hand panels to allow for centerline latch clearance.

Each PLBD has two deployable (Panels 1 and 2) and two fixed (Panels 3 and 4) radiator panels. The deployable panels can be deployed to an angle of 35.5°, which allows heat transfer from their upper and lower surfaces. Most missions do not require the additional heat transfer provided by deploying the forward panels. The fixed panels facilitate heat transfer from their upper surface and are non-deployable.

3.2 INTERNAL RADIATOR STRUCTURE

3.2.1 Structural Layers

The radiators are aluminum sandwich panels coated with a silver-Teflon adhesive tape. The aluminum sandwich panel supplies stiffness and rigidity to the internal Freon-21 tube bank and manifold. Silver-Teflon tape reduces the solar energy absorption and increase heat transfer from the Freon-21 to space.

The aluminum sandwich panel consists of a 5056-H39 aluminum honeycomb core and 0.011 inch thick 2024-T81 aluminum face sheets. The thickness of the face sheets do not change between the deployable and fixed radiator panels, but the thickness of the honeycomb material changes from 0.90 to 0.50 inches, respectively. 5056-H39 aluminum honeycomb weights 3.1 pounds per cubic foot; therefore, the honeycomb

material for a fixed radiator panel weighs approximately 20.5 pounds (see Fig. 3.2.2.2 for dimensions used).

The silver-Teflon tape is multilayered and is supplied by a vendor to the Vought Corporation (the Dallas based manufacturer of the radiator panels). The tape is applied to the radiator panels in rows with a small gap between the rows to prevent overlap. This tape consists of eight layers, including a removable protective coverlay (protecting the outer layer) and a removable release liner (protecting the lower adhesive layer). The thicknesses of the layers range from a 300 Å Inconel layer to a 5.5 mil (1,397,000 Å) Teflon layer. The layer of silver was originally designed as a flat sheet of silver, but has been since redesigned as an adhesive sheet impregnated with diffused silver "droplets" (see Fig. 3.2.1.1). These droplets, through their reflective scattering properties, give the radiator panels a textured appearance.

Figure 3.2.1.2 shows the layered configuration of the tape, but it has not been drawn to scale.

Figure 3.2.1.1:

Diffused Silver in the Radiator Panel Tape

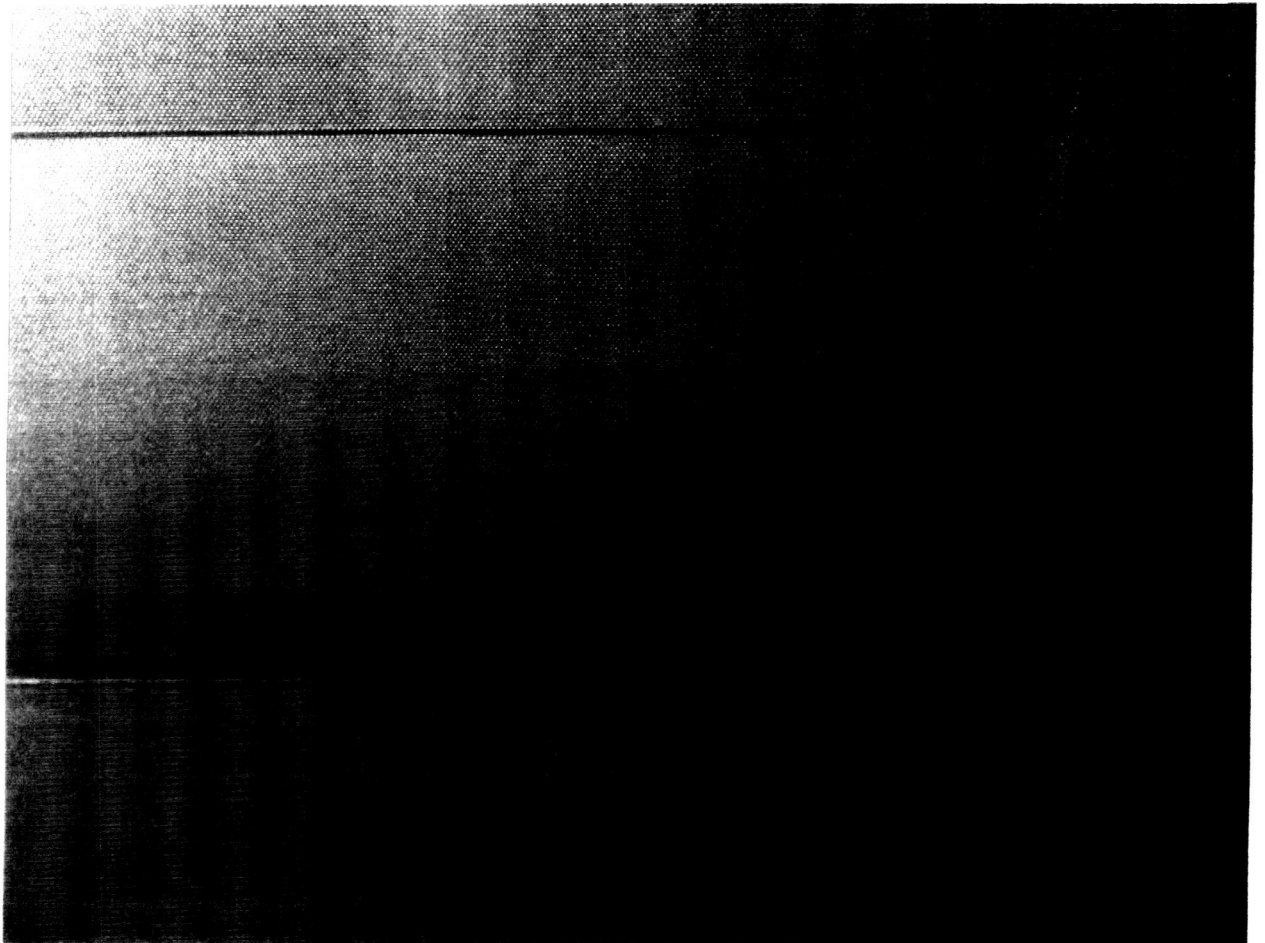
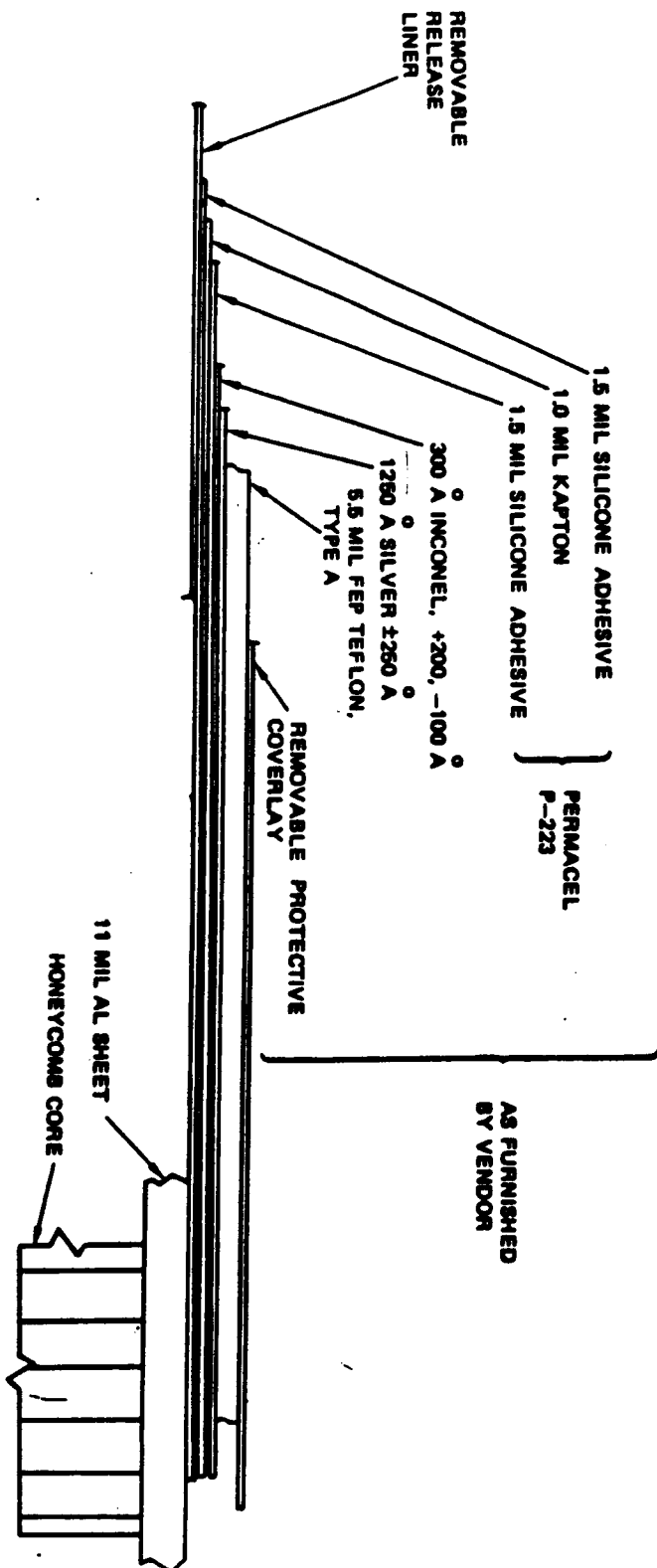

Figure 3.2.1.2:

Layered Tape Bonded to the Radiator Panels



3.2.2 Freon-21 Tube Bank and Manifold

The Freon-21 tube bank and manifold are designed to efficiently transfer Freon-21 to a location where heat transfer can occur and to collect the Freon-21 in order to get it back into circulation around the orbiter. The fixed and deployable radiator panels have 5083-H32 aluminum manifolds on the fore and aft ends for Freon-21 collection. Each manifold is a 7/8 inch diameter pipe with a 0.035 inch wall thickness. The tubes, made of 6061-T6 aluminum, are welded into the manifold. 5083-H32 aluminum was chosen for the manifold because of its high strength weld properties. 4043 aluminum filler material is used around the weld joints (see Fig. 3.2.2.1). Freon-21 flows from the aft manifold to the forward manifold of each radiator panel in parallel, but it flows between the radiator panels themselves in series. Fig. 3.2.2.2 shows the inlet and exhaust manifold connection locations for the deployable and fixed radiator panels.

Figure 3.2.2.1:

Radiator Manifold Details

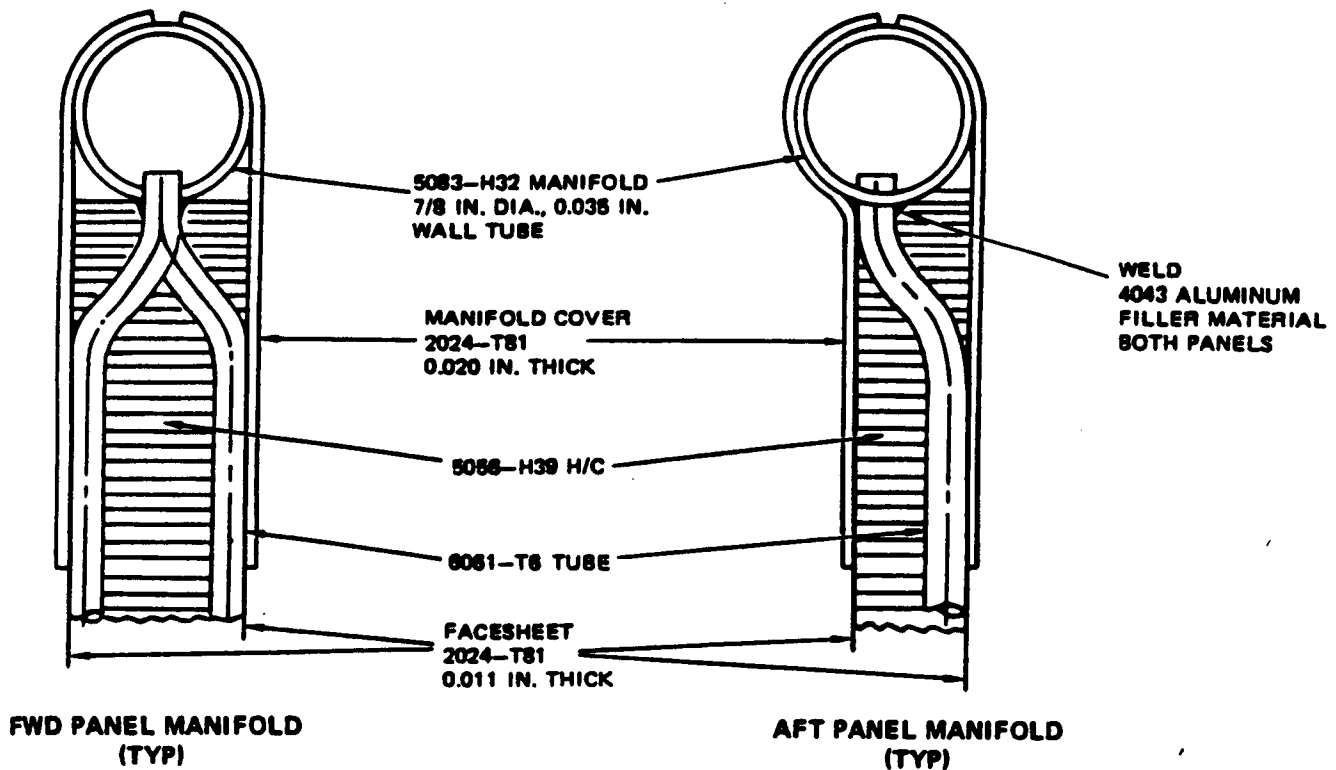

More hose is required to transport Freon-21 from the sill longeron to the radiator panels when the PLBDs are open than when they are closed. This "extra" hose is housed on a take-up reel, located underneath the sill longeron, when not in use. The hose is automatically pulled off of the reel when the doors are being opened and wound up when the doors are being closed.

Figure 3.2.2.2:

Typical Radiator Panel Physical Characteristics

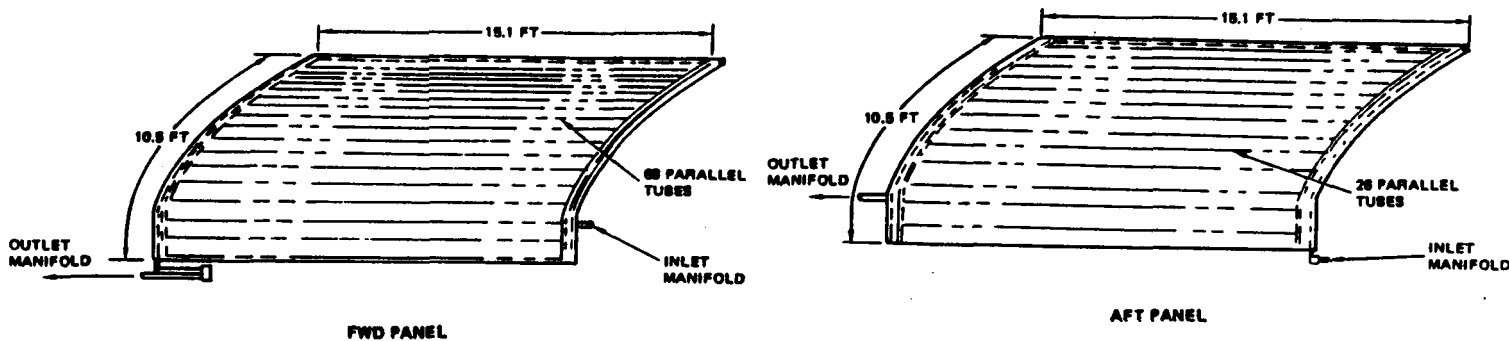

Fig. 3.2.2.3 shows that the number of tubes, the tube size, and the orientation of the tubes varies between the deployable and fixed radiator panels (note the difference in scale between the two drawings). This is because the deployable radiators need tubes attached to both face sheets in order for them to radiate heat from both sides of the radiator. The tubes for the deployable radiators are smaller than the tubes in the panels of the fixed radiators (0.187 inches compared 0.236 inches), but the distance between the tubes is reduced from 5.0 inches to 1.9 inches.

The tubes are bonded to the aluminum face sheets with Marmco Methlbond 329-7 adhesive, applied in a small line to promote efficient heat transfer. It is laced with aluminum to aid heat transfer and to give a thermal expansion coefficient similar to aluminum and thus increase the strength of the bond. V-shaped grooves, cut in the honeycomb material, give the tubes area to travel down. This grooves are cut smaller than needed so the tubes slightly crush the honeycomb, which

causes it to constantly push the tubes against the face plate and facilitate a higher heat transfer efficiency.

Figure 3.2.2.3:

Radiator Panel Honeycomb with Freon Tubes

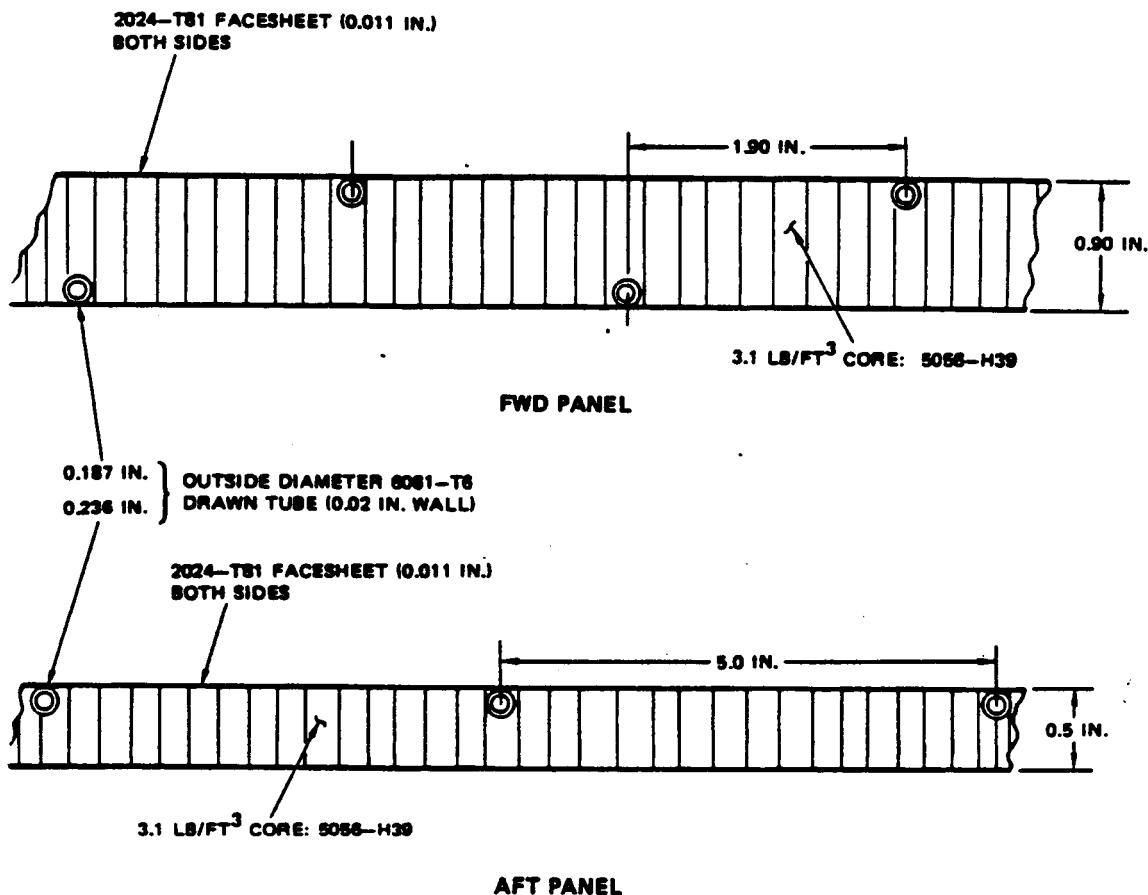

3.2.3 Attach Points

The radiator attach points are covered in Chapter 2.2.4, but drawings of all eight radiator panels can be seen in Figs. 3.2.3.1 through 3.2.3.8. Each panel is connected to the PLBDs by only one point which holds the X₀-location fixed. Therefore, the floating scheme incorporated in the radiator panel system is similar to that of the PLBD system. The radiator panels and PLBDs are not structural members of the orbiter, so the floating attach system allows for thermal expansion/contraction, bending, and twisting but does not impart orbiter loads.

Figure 3.2.3.1:

Right Hand Radiator Panel 1 Structural Arrangement

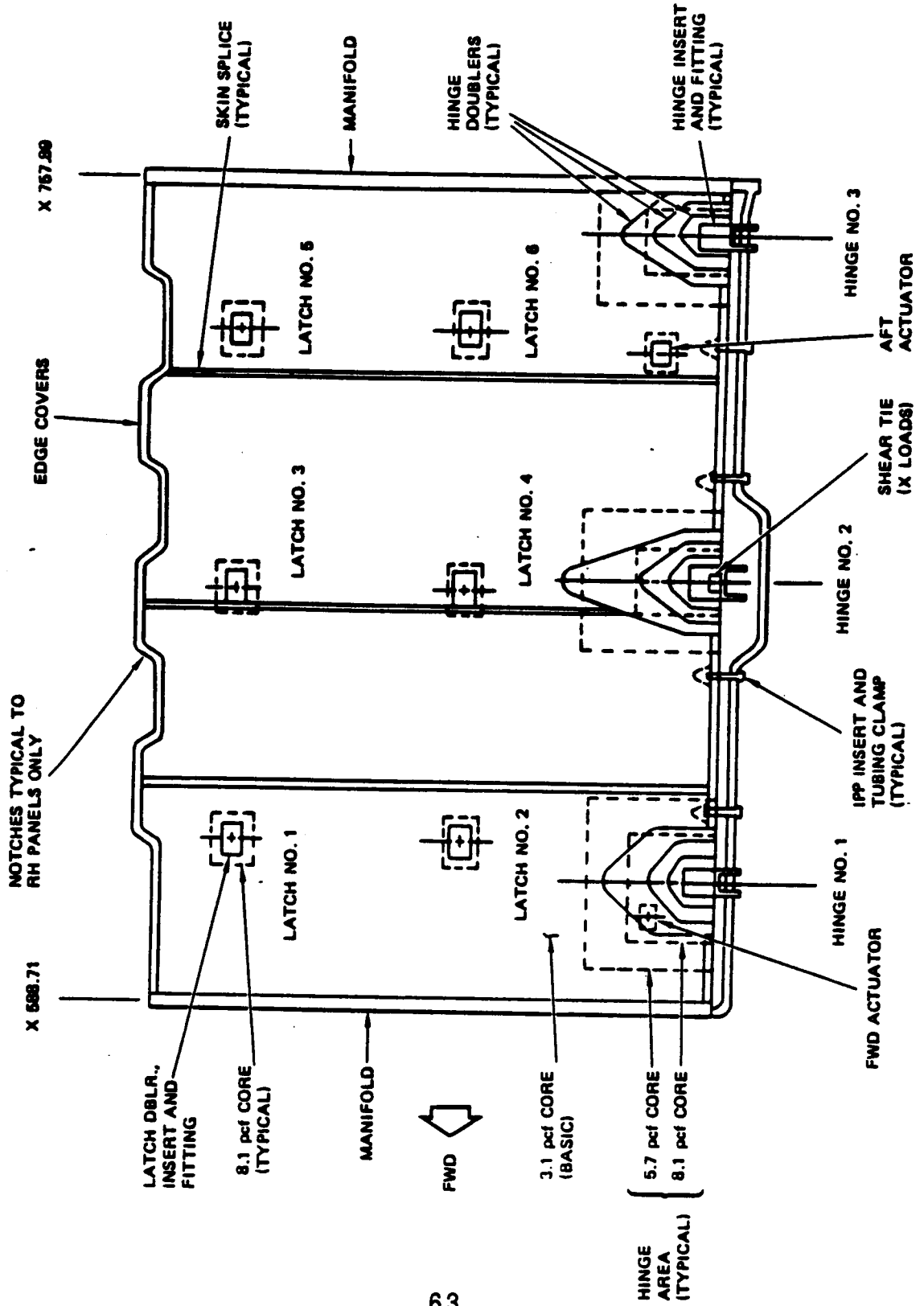

Figure 3.2.3.2:

Left Hand Radiator Panel 1 Structural Arrangement

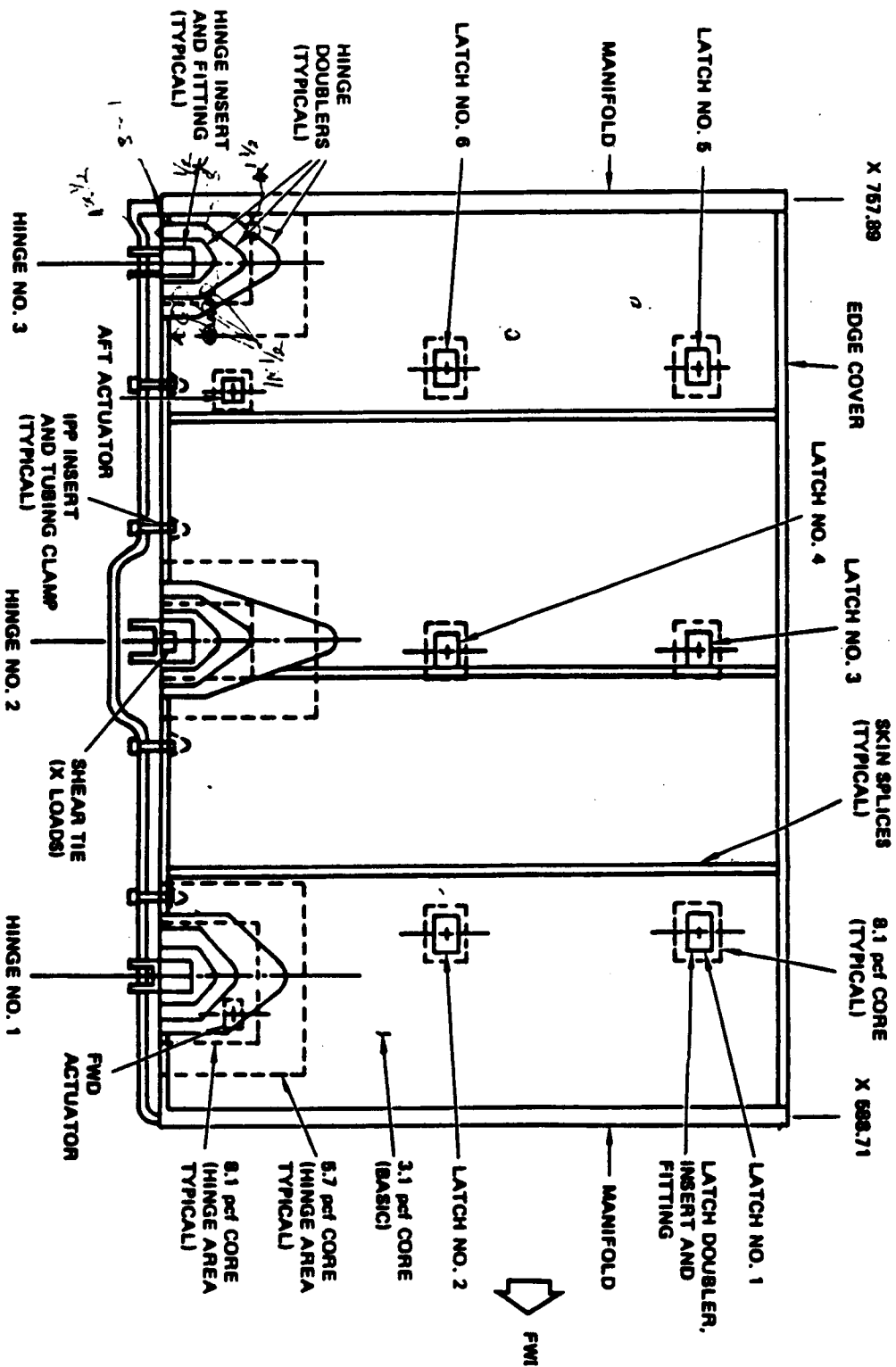

Figure 3.2.3.3:

Right Hand Radiator Panel 2 Structural Arrangement

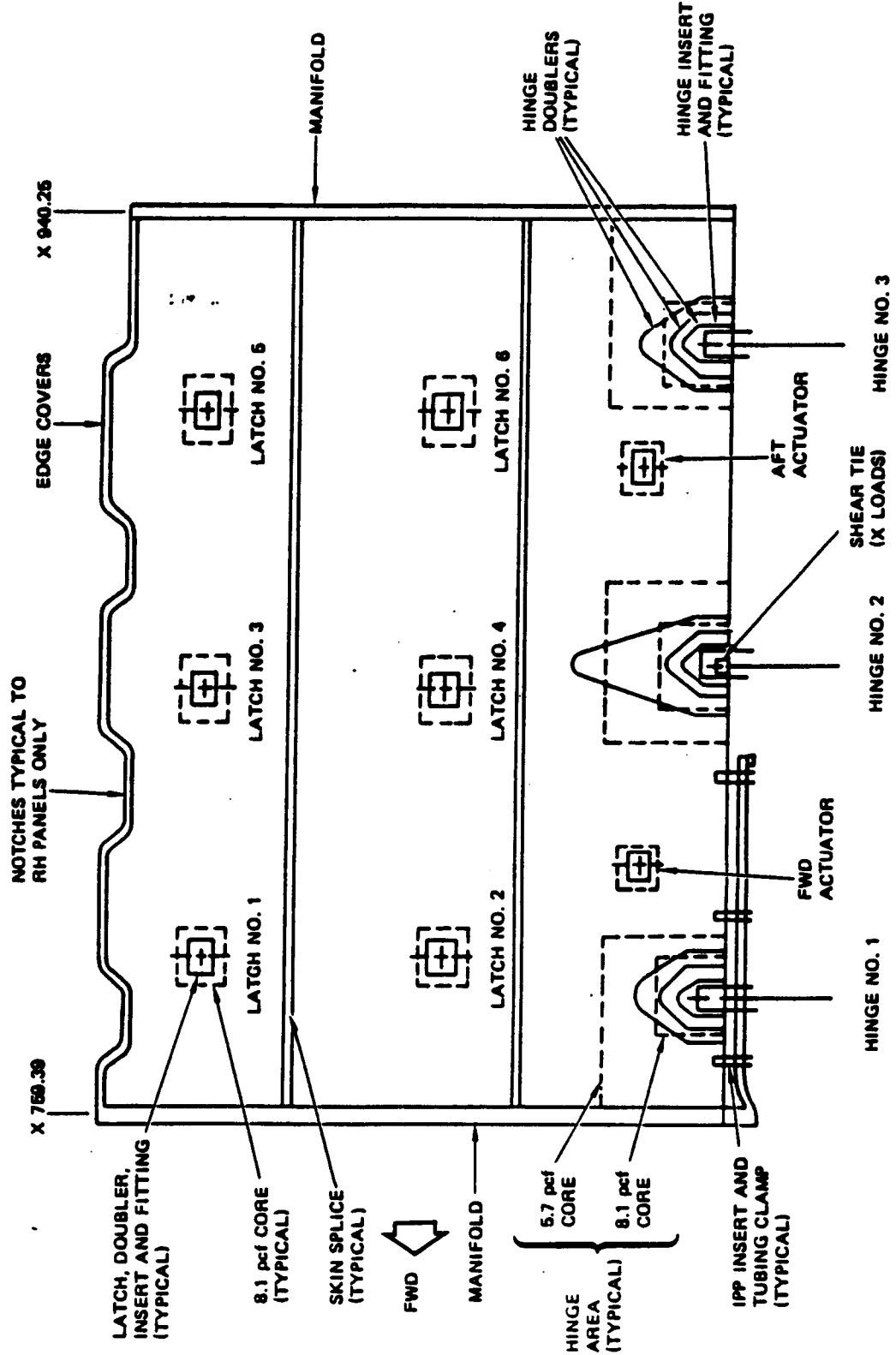

Figure 3.2.3.4:

Left Hand Radiator Panel 2 Structural Arrangement

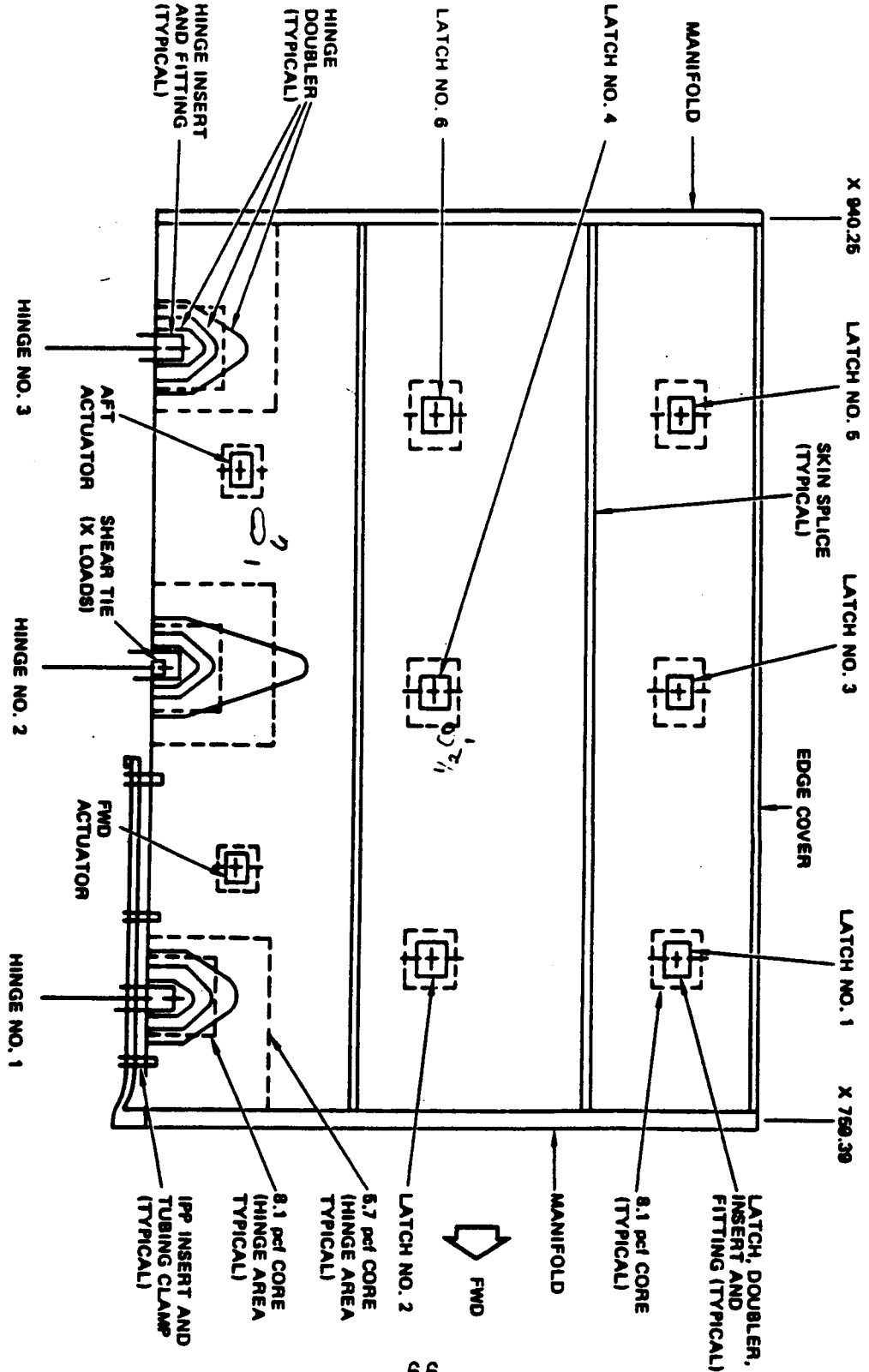

Figure 3.2.3.5:

Right Hand Radiator Panel 3 Structural Arrangement

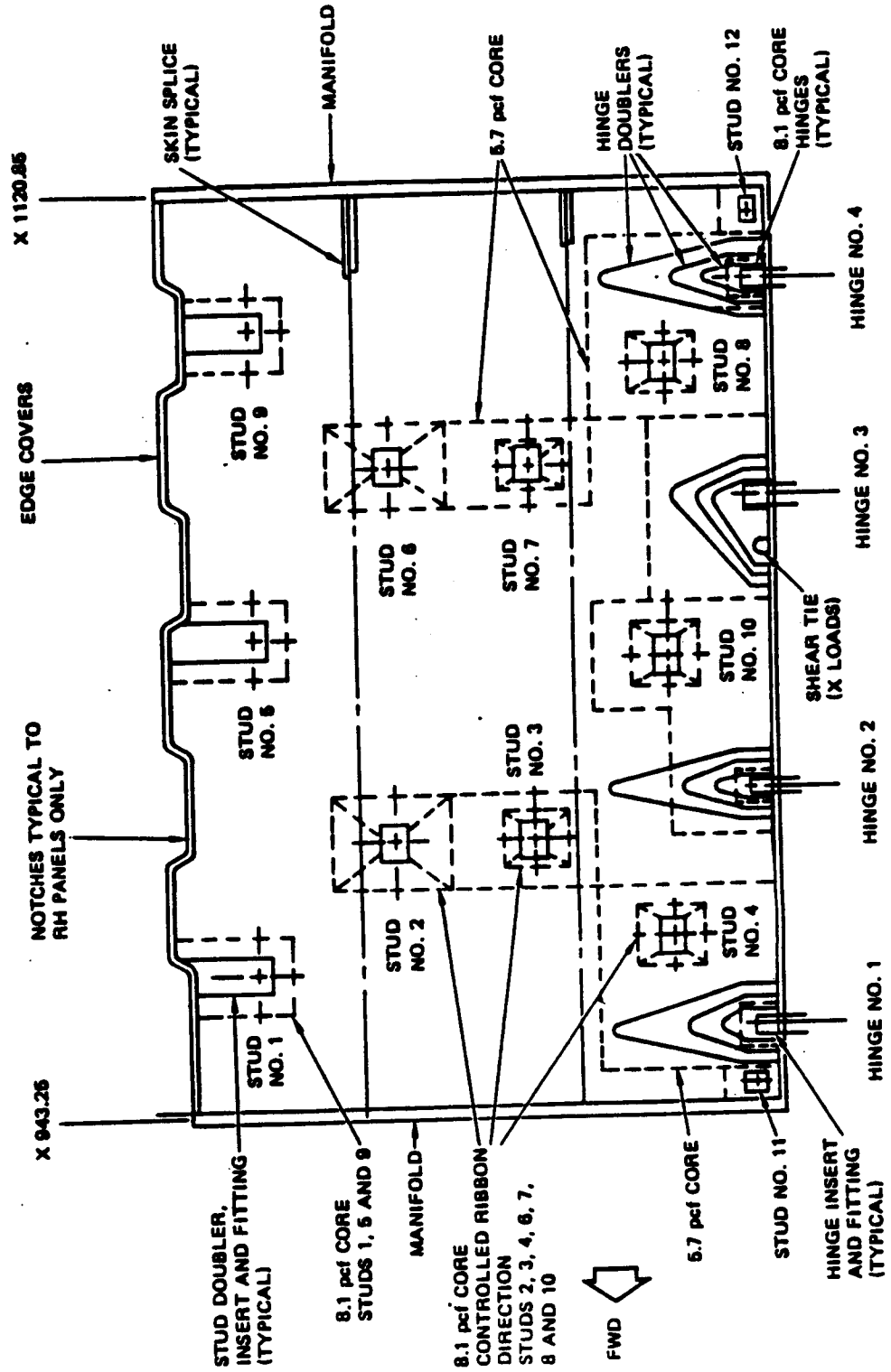

Figure 3.2.3.6:

Left Hand Radiator Panel 3 Structural Arrangement

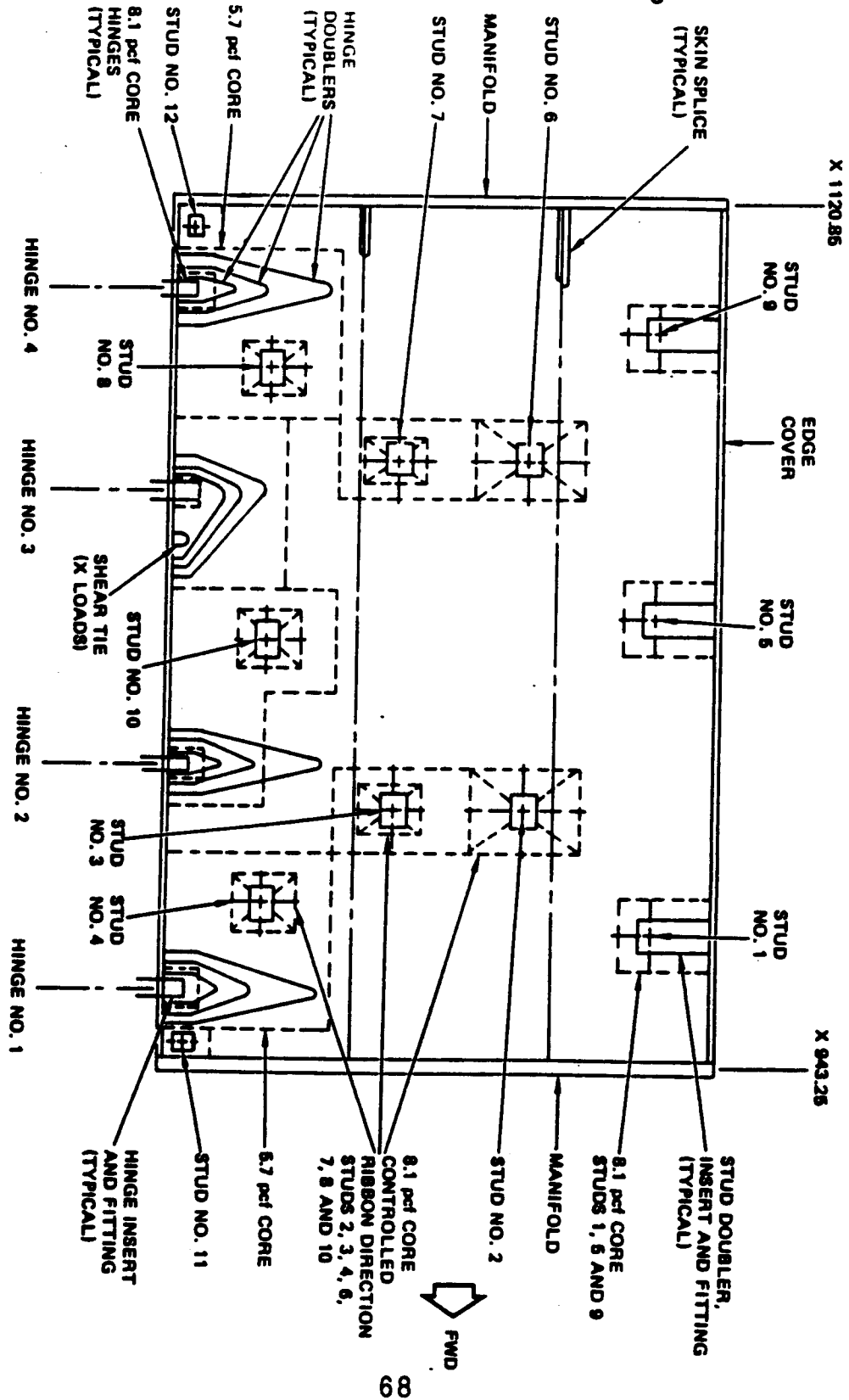

Figure 3.2.3.7:

Right Hand Radiator Panel 4 Structural Arrangement

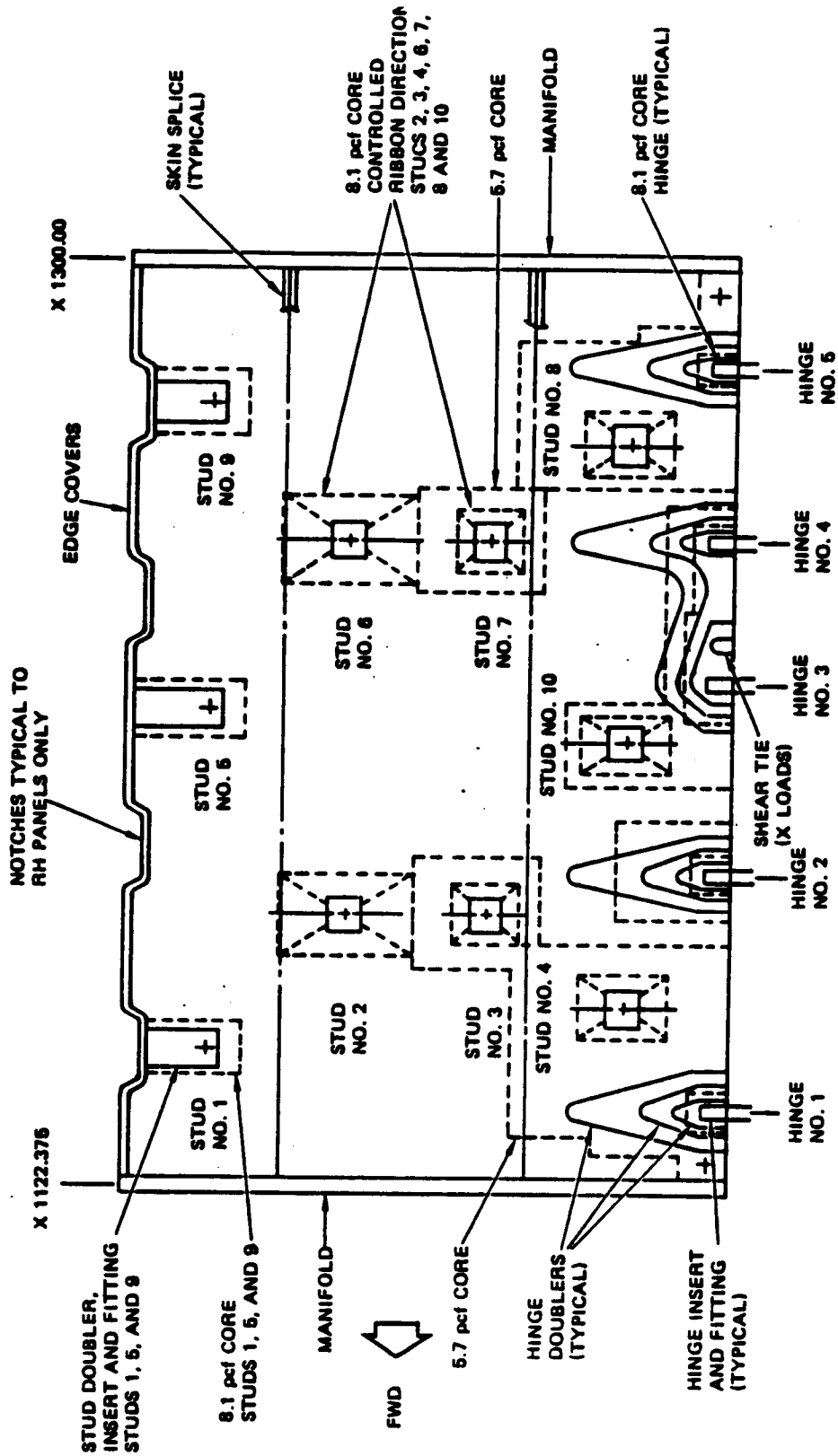
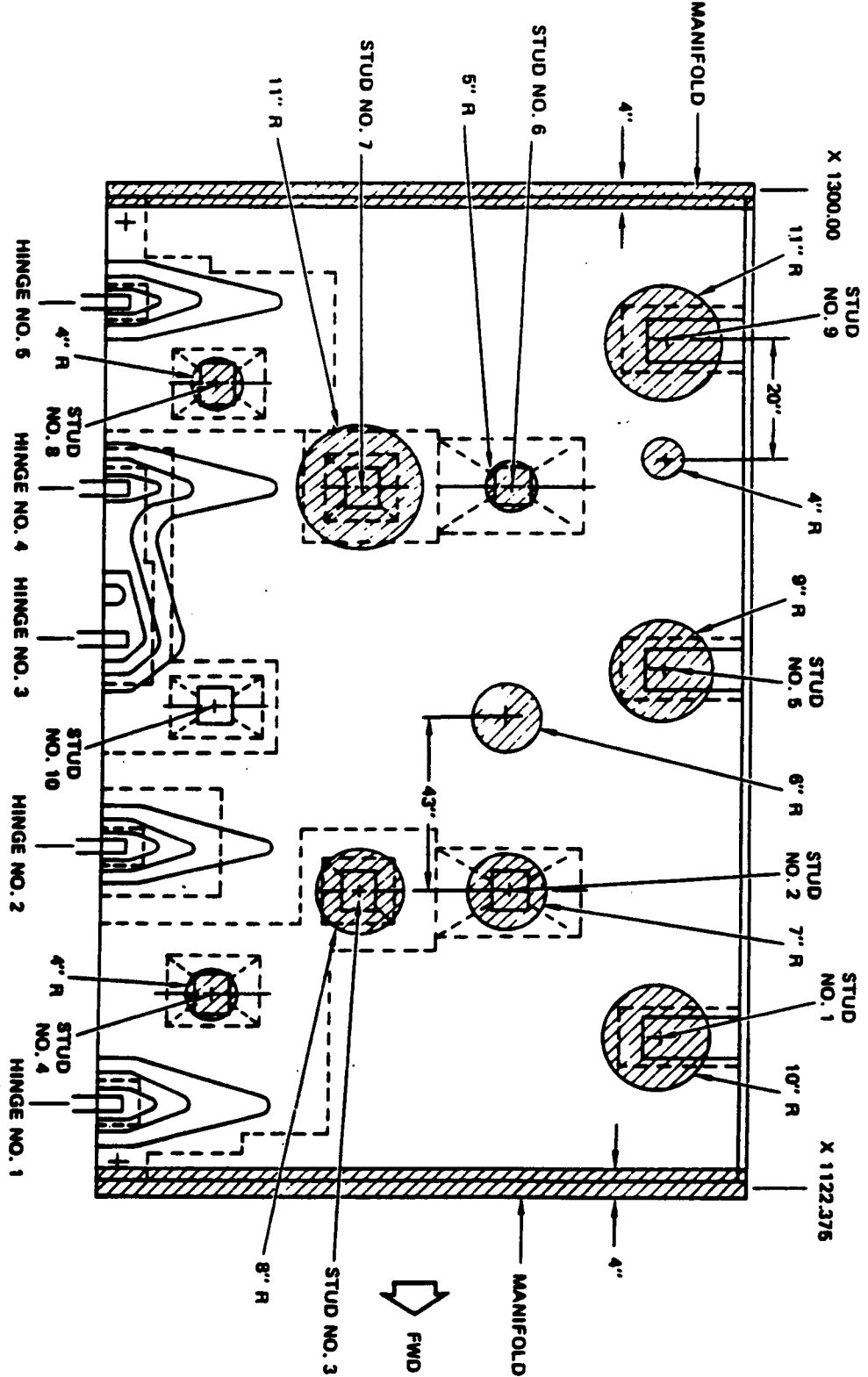

Figure 3.2.3.8:

Left Hand Radiator Panel 4 Structural Arrangement



3.3 DEPLOYABLE (FORWARD) RADIATOR MECHANISMS

3.3.1 Latch Mechanisms

The forward radiators have latches which allow them to latch to the PLBDs when in the stowed position, or to be unlatched (except at the hingeline) from the PLBDs when in the deployed position. Each of the forward radiator panels have two sets of three latches and attach rollers and a PDU (Power Drive Unit) to drive the latches. The rotary power output from the two three-phase motors of the PDU is converted with an eccentric into linear motion which actuates the latch mechanism. The motors operate in both directions which give the system the opening and closing capability.

3.3.1.1 Power Drive Units/Differential/Torque Limiter

The two, three-phase motors (operated at 115 VAC and 400 Hz), are connected to the rotary output shaft through a differential. However, unlike the other PDU systems, a torque limiter is placed between each motor and the differential. The rotary output from the PDU is transmitted via torque tubes to three actuators. The schematic and the actual mechanism for the PDU can be seen in Figs. 3.3.1.1.1 and 3.3.1.1.2 respectively.

Figure 3.3.1.1.1:

Radiator Deployment Schematic

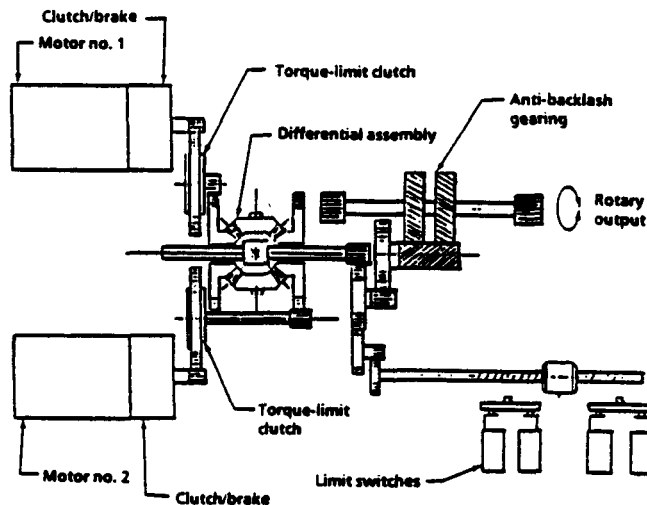
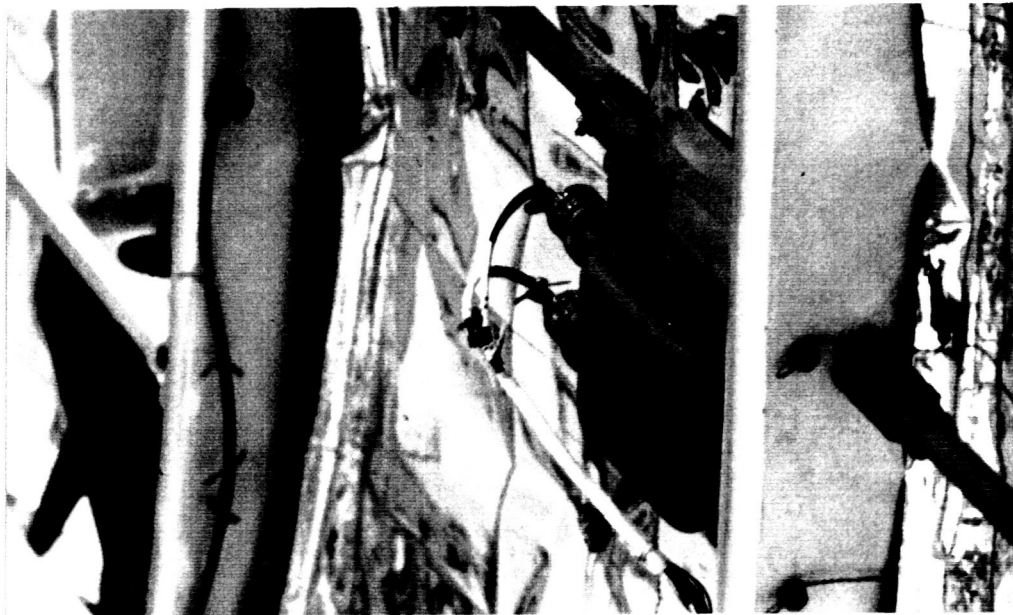

Figure 3.3.1.1.2:

PDU for the Radiator Latching Mechanism



3.3.1.2 Rotary Actuators

The actuators use an eccentric to convert rotary power into linear power. The torque shaft runs through and turns a collar. Two bellcranks are connected to the collar and pinned to one push-pull rod each. As the torque shaft turns, a linear motion is experienced by the push-pull rods. Each actuator drives two push-pull rods which each drive one latch. Therefore, each actuator drives two latches. This linkage system can be seen in Fig. 3.3.1.2.1.

Figure 3.3.1.2.1:

Linkage for the Radiator Panel Latch System

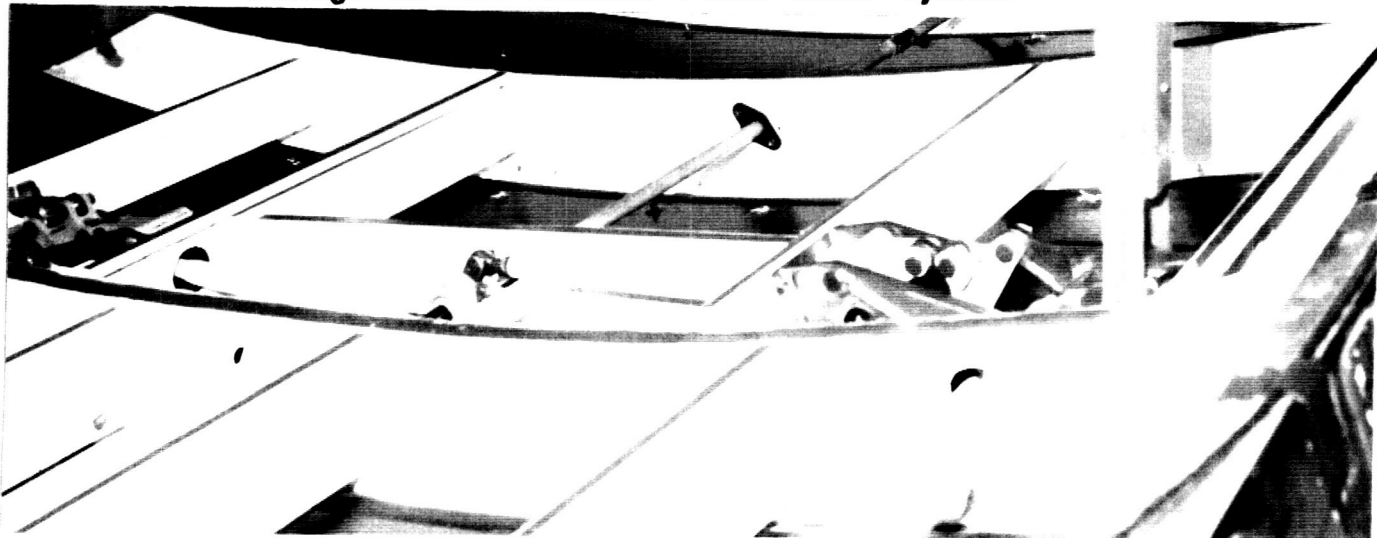

3.3.1.3 Latch Hooks and Rollers

The latch hook system takes the linear translation of the push-pull rods and through linkages, allows the latch hooks to engage the rollers attached to the radiator panels. This linkage system is illustrated in greater detail in Fig. 3.3.1.3.1. The point of connection between the latch hooks and the rollers, holds the radiator panels to the PLBDs and allows for independent thermal expansion/contraction, bending, and twisting of the orbiter. A latch and a roller can be seen in Figs. 3.3.1.3.2 and 3.3.1.3.3, respectively.

Figure 3.3.1.3.1:

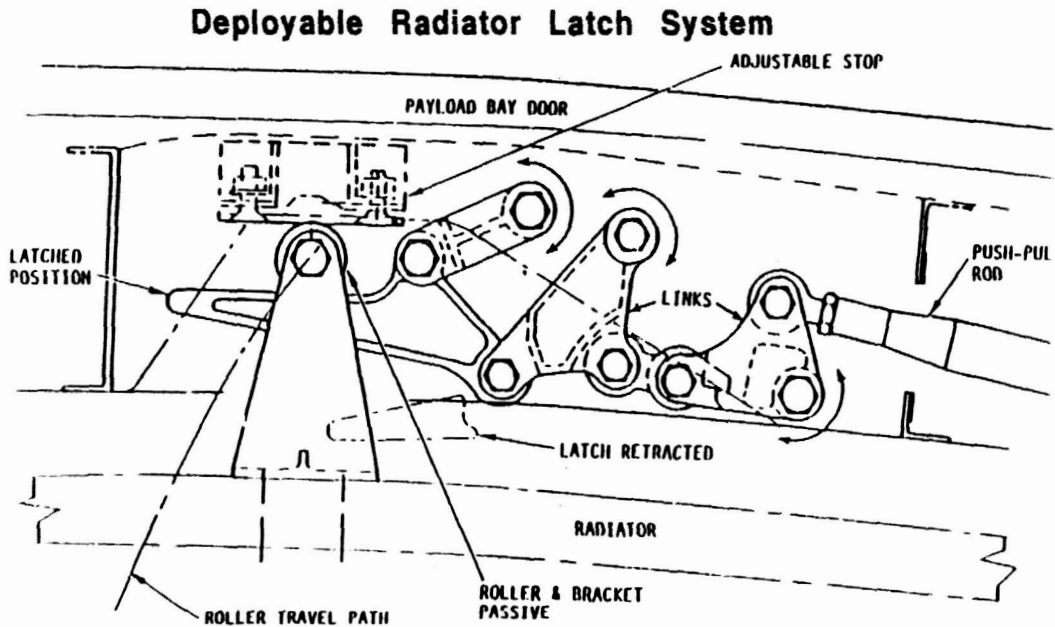

Figure 3.3.1.3.2:

Deployable Radiator Panel Latch



Figure 3.3.1.3.3:

Deployable Radiator Panel Roller

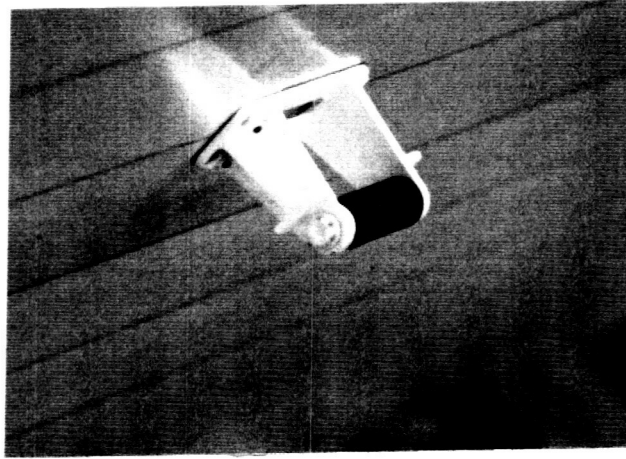

3.3.1.4 Latch Switches

Latching and unlatching is performed on the R13 panel (located on the starboard side of the aft flight deck) and must be performed manually. Each PDU has a set of two latched and two unlatched limit switches (see Fig. 3.3.1.1.2). The limit switches turn the motors off when the latches are latched or unlatched and also act as a talkback to the R13 panel to relay the position to the crew member operating the system. The limit switches also turn the drive motors off when the time needed to drive the latches with one motor inoperative is reached and no latched/unlatched indication has been received.

3.3.2 Deployment Mechanisms

The radiator panels are driven to the deployed or stowed position in sets of two panels. The port and starboard sets are each driven by one mechanism, unlike the latching system. Therefore, panel 1 or panel 2 can not be driven independently. The deployment mechanism consists of a PDU, four rotary actuators with bellcranks, a torque tube with couplers, and limit switches.

ORIGINAL PAGE
COLOR PHOTOGRAPH

3.3.2.1 Power Drive Units/Torque Limiter/Differential

The PDU's schematic for the radiator panels is the same as the latch/unlatch PDU schematic. The PDU drives four rotary actuators (2 per panel) instead of three, which is the only difference between the two systems. Refer to Fig. 3.3.1.1.2 and Section 3.3.1.1 for a detailed explanation.

The PDU, which drives the two panel set, is located underneath the aft deployable radiator panels. The PDU, the torque shaft, and a single deployment actuator can be seen in Fig. 3.3.2.1.1.

Figure 3.3.2.1.1:

Radiator Panel Deployment Actuation



3.3.2.2 Rotary Actuator/Bell Crank

A rotary actuator, connected to a bellcrank, rotates with the torque tube and drives the radiator panel set to the deployed or stowed position. The bellcrank, which is connected to the radiator panels by a linkage, rotates a total of 92° from stowed to deployed. This 92° rotation translates to a radiator panel rotation of 35.5° .

Each panel has two rotary actuators located at the forward and aft ends of the panels. Since they are connected to the same PDU, the actuators open the panel sets at the same time and speed.

3.3.2.3 Torque Tube/Couplers

The torque tubes transfer power from the PDU to the rotary actuators. These tubes must drive the actuators in unison to prevent racking and subsequent transfer of stress to the panels. The panels are not designed to carry external stress loads. Couplers are rigged to set the timing and to synchronize the actuators.

3.3.2.4 Limit Switches

The four limit switches, two stowed and two deployed, relay a stowed, deployed, or an in transition indication on the R13 panel for the crew. The switches shut off power to the PDU motors when the driven position has been reached. A precautionary measure has been built into this system. If the commanded indication is not reached within the time it would take for one motor to drive the panels, power is automatically shut off to the PDU motors.

3.4 FIXED (AFT) RADIATOR MECHANISMS

The aft radiator panels remain fixed throughout flight. Panels 3 and 4 are attached to the PLBDs with similar hardware, but in different configurations. Figs. 3.2.3.5 through 3.2.3.8 show the floating studs, the hinges, and one shear tie (for x-loads) required for attachment of the radiator panels to the PLBDs. The hinges allow the panels to be raised and lowered independently in the OPF (Orbiter Processing Facility) with the use of GSE. However, the fixed panels are normally removed for inspections and maintenance. Fig. 3.4.1 shows support bars holding the starboard deployable radiator panel set in the deployed position.

Figure 3.4.1:

Radiator Panel GSE Support Bars

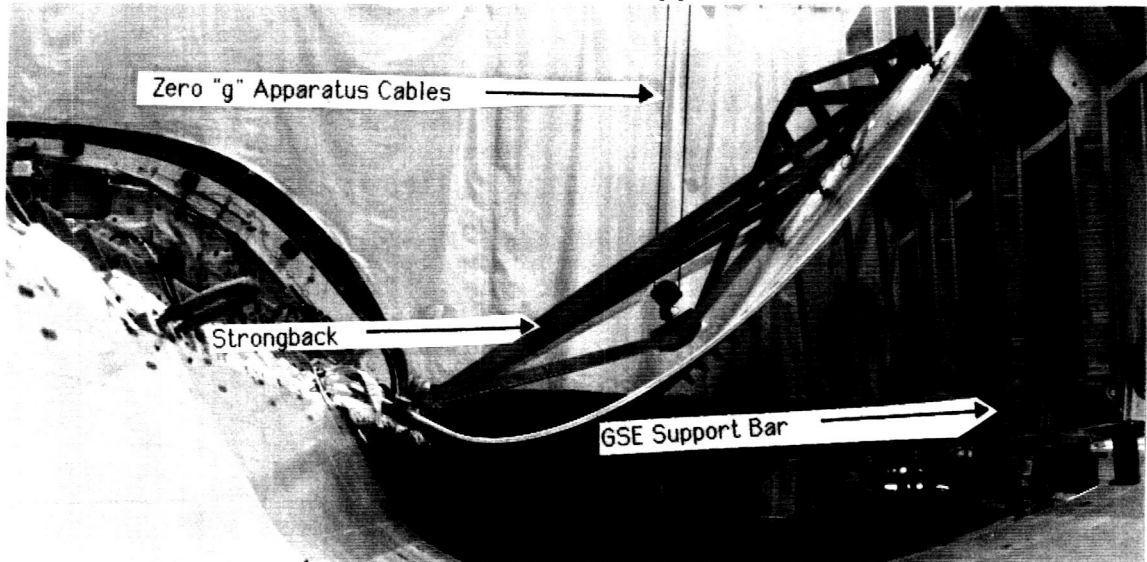

3.5 RADIATOR DEPLOYMENT

3.5.1 Horizontal

Since the radiators can cause a loss of mission if they can not be deployed, the OMRSD (Operation and Maintenance Requirements and Specifications Documentation) states that radiator functionals must be performed every 18 months or before a flight which requires their deployment. Radiator functionals are performed in the OPF as part of required maintenance to insure the ability to utilize the underside of the forward radiators as required or for contingency cooling.

Radiators are deployed in the OPF using the zero "g" system and strongbacks, because the radiators, like the PLBDs, are designed to open in the weightlessness of space. One strongback is connected to each radiator panel set and to the zero "g" system (see Fig. 3.4.1). The weight basket for each of the forward PLBD segments is actually two baskets; one has a weight equal to the weight of the radiator panels and the other has a weight equal to the PLBD system minus the weight of the radiator panels. When a radiator functional is being performed, the baskets are unpinned and only the radiator panel weight basket is used. The PLBDs are required to be at the 145° maintenance position while the radiator functional is being performed.

3.5.2 On Orbit

The radiators are controlled manually from the starboard aft flight deck with the R13 panel (see Fig. 3.5.2.1). This panel controls the power of SYS A and SYS B, which are independent power sources for both motors of the latch and deploy systems.

The initial indications and switch locations are shown in Fig. 3.5.2.1. The procedure for deploying a radiator panel is a relatively simple. The latches are unlatched first by flipping the SYS A and/or SYS B switches. During the transitional unlatching stage, the indicators for the STBD and PORT latches show a "barberpole." After the indicators show REL (released), the deployment drive motors are activated by flipping the Radiator Control switches (SYS A and SYS B) to deploy. The transition is again indicated with a barberpole, followed by a DEP (deployed) when the radiator panels are in the deployed position.

Stowing the radiator panels is the reverse of the deploying procedure. It should be noted in Fig. 3.5.2.1 that the STBD (starboard) and PORT switches are opposite from what their names indicate. This decreases the confusion created by looking aft while performing the deployment procedures.

Figure 3.5.2.1:

Radiator Controls and Displays

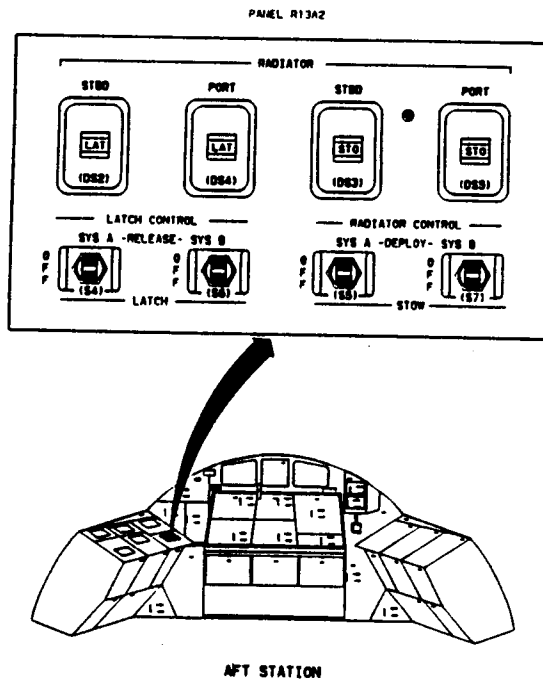

3.6 RADIATOR INSPECTION AND CLEANING

3.6.1 Visual Inspection

Radiators are very sensitive and vital hardware for the orbiter. Their surface can be dented or punctured (termed "dinged") by objects in space and by processing personnel in the OPF or the PCR. Ensolate Protective Covers are positioned on top of the panels during normal OPF operations to prevent inadvertent damage to the radiators.

The radiator panels are inspected as soon as the PLBDs are open by personnel in the bridge buckets. Dings that are located are mapped using a two axis coordinate system and entered onto the "Radiator Panel Ding Map." If the ding is not already on the map, a PR (Problem Report) is written and a dental mold impression is taken of the ding to facilitate a complete overview by engineering.

3.6.2 ARID - Robot Radiator Inspection

Inspection of the radiator panels is a labor intensive process (16 people for 24 hours). A radiator inspection robot is currently in design to aid in the radiator inspection process. The ARID (Automatic Radiator Inspection Device) would allow personnel to work other jobs, while it performs the radiator inspections. The system will provide a more accurate permanent record of radiator damages, including small imperfections which the human eye might miss. Fig. 3.6.2.1 shows an OPF mock-up of the robot at the Robotic Applications Development Laboratory and Fig. 3.6.2.2 shows the robot connected to its support beam under the 13 platforms in the OPF mock-up.

Figure 3.6.2.1:

ARID in the Robotic Applications Development Lab

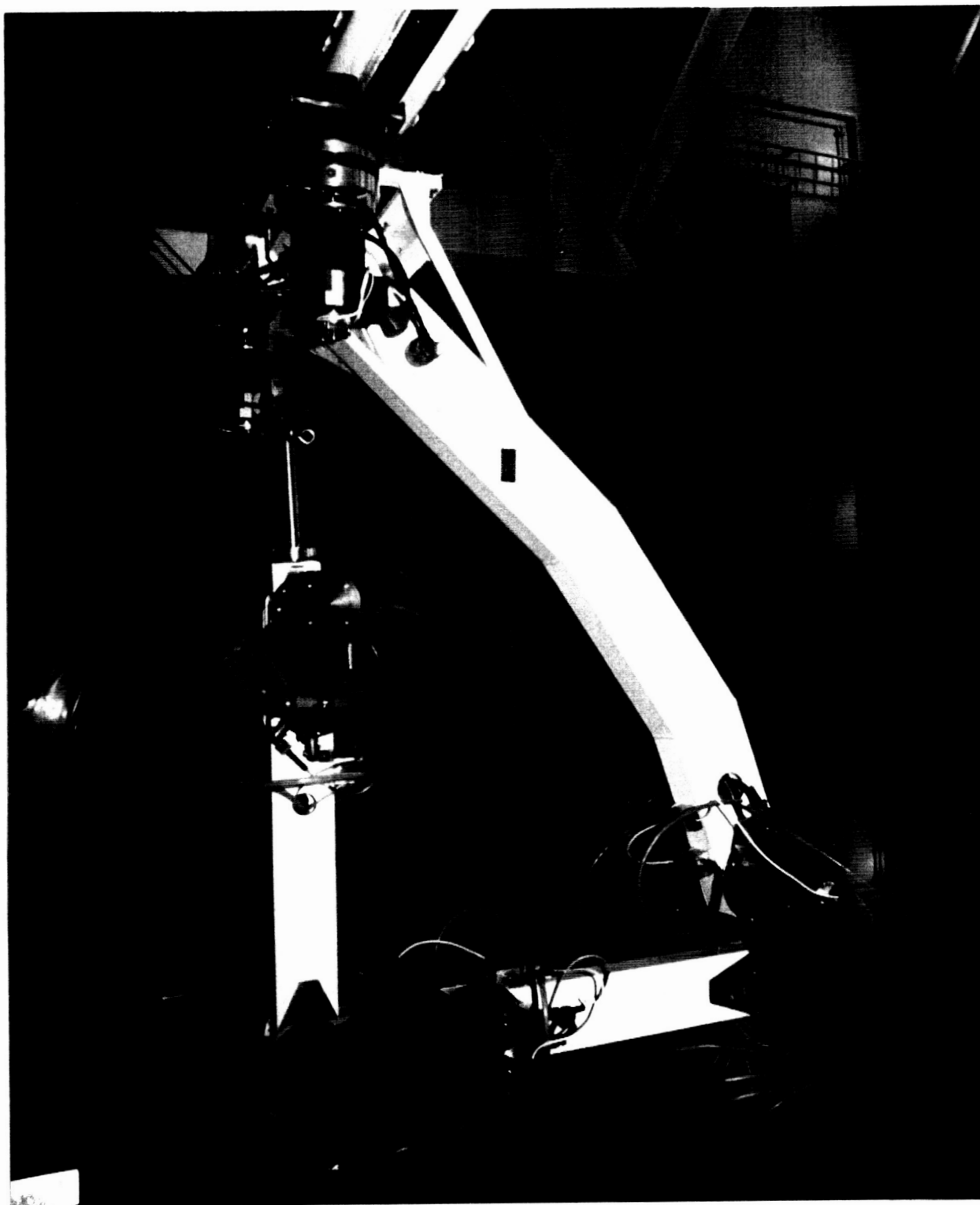
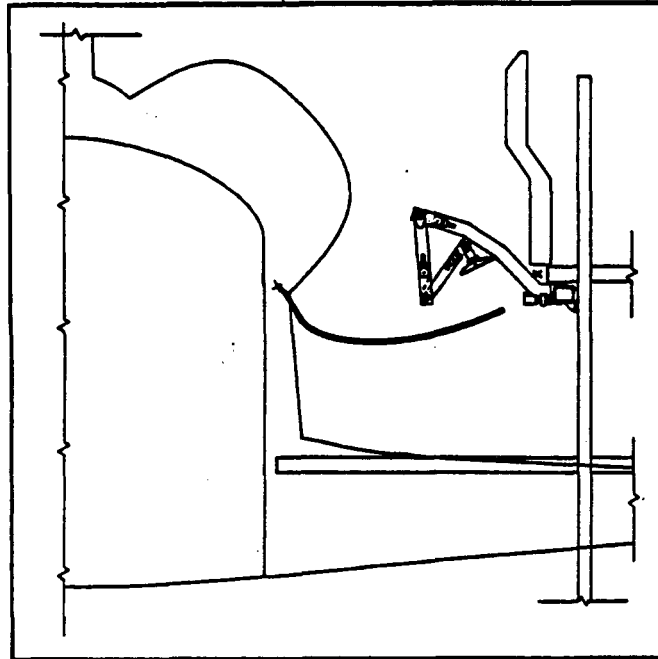

Figure 3.6.2.2:

ARID Storage Position



3.6.3 Radiator Cleaning

The radiator panels were originally designed to not require cleaning, rather, the surface coating to be replaced when dirty. However, cleaning has become regular maintenance. Each time cleaning is performed, more and more of the Teflon surface coating is scratched, which decreases the efficiency of the panels. This efficiency was a major design factor, however, the radiators work so well, the deployable radiators do not have to be deployed as often as originally intended and decreases in efficiency, due to cleaning, are acceptable.

The radiators are cleaned using a low lint cloth with a solution of 80% isopropyl alcohol and 20% trichloroethelene. The panels are wiped "with the grain" of the tape strips to prevent the strips from curling up along the seams. After the panels have been cleaned, a six hour drying time is required before closing the PLBDs.

The radiator panels are sensitive to oils. If they must be touched by human hands, cloth or latex gloves should be worn.

3.7 ACTIVE THERMAL CONTROL SYSTEMS (ATCS)

The radiator panels are only one part of the ATCS (Active Thermal Control System). The ATCS regulates the temperature of many systems vital to the safety of the crew and mission. This handbook is not to describe the ATCS. The following is an ATCS mission profile and describes the major components of the ATCS.

3.7.1 Mission Profile

Until T-0, heat is rejected from the orbiter's Freon-21 by ground cooling lines of Freon-114 through the T-0 umbilicals. The orbiter is coldsoaked prior to launch, because from T-0 until approximately 140,000 feet (2 minutes and 15 seconds), the Freon-21 merely acts as a passive heat sink. From 140,000 feet until the opening of the PLBDs and the activation of the radiator panels, the Flash Evaporator System (FES) provides total orbiter cooling. The radiator panels provide the majority of heat rejection during the on-orbit phase of the mission. The Freon Coolant Loops are coldsoaked and the PLBDs are closed about 2 hours and 45 minutes prior to reentry. The FES provides the orbiter cooling from PLBD closure until it loses its effectiveness at approximately 140,000 feet. After the coldsoak has been expended and below an altitude of approximately 100,000 feet, the Ammonia Boiler Subsystem (ABS) can be activated to provide cooling until GSE cooling can be initiated. The ABS is not always required, since some missions do not have a high reentry heat load which permits the coldsoak to last until GSE cooling can be initiated.

3.7.2 Flash Evaporator Subsystem

The Flash Evaporator Subsystem (FES) is only functional at low or zero pressures. Low ambient pressure is required to vaporize water to use its latent heat capacity to dissipate heat. Pressure is the factor which governs the activation and deactivation altitudes for ascent and descent, respectively.

The FES consists of a topping and hi-load section which allows it to operate in either a full-up (hi-load and topping), topping only, secondary topping, or secondary hi-load configuration. In full-up configuration, the FES can singly reject the orbiter's heat load at 131,000 Btu/hr. The secondary modes, both hi-load and topping, can

reject 67,500 Btu/hr. The topping mode, used to supplement radiator cooling and to dump excess water, can reject 30,000 Btu/hr.

Fig. 3.7.2.1 shows the Flash Evaporator Subsystem.

Figure 3.7.2.1:

Flash Evaporator Subsystem

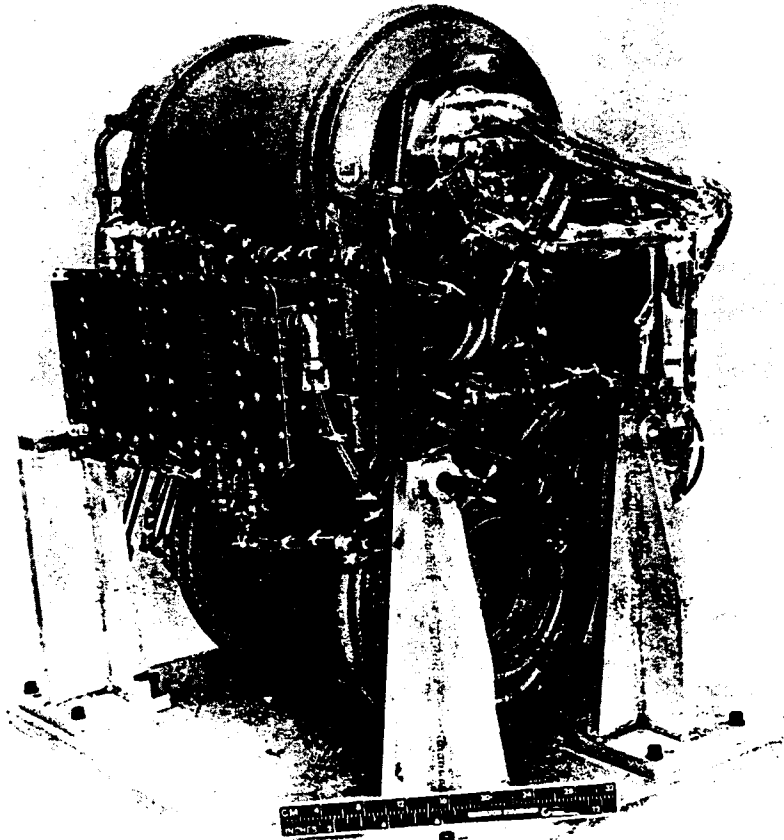

3.7.3 Ammonia Boiler Subsystem

The Ammonia Boiler Subsystem (ABS) dissipates heat from Freon-21 Coolant Loops by boiling liquid anhydrous ammonia in a tube-shell heat exchanger and dumping the vapor overboard. The subsystem consists of two ammonia boilers, which can each reject 113,200 Btu/hr for 15 to 30 minutes.

The ABS is designed to run from a descent altitude of 100,000 feet until GSE cooling can be established. The ABS controller can be switched to the ON-GPC position which commands the GPC (General Purpose Computer) to turn the ABS on at an altitude of 100,000 feet. The coldsoak, prior to reentry, usually is not depleted by the time the orbiter reaches 100,000 feet, so the ABS is usually not activated unless needed.

4. PRECAUTIONARY MEASURES

4.1 TIMING SWITCHES

Switches have been built into all mechanisms of the PLBD (Payload Bay Door) and radiator panel systems. The PDU (Power Drive Units) for these mechanisms have two motors but can operate on just one for redundancy, in case one motor ceases. Operation of a mechanism with one functioning motor takes twice the time required for two motor operation. Timing switches have been built into the checkout software used to drive the PLBD and radiator panel mechanisms. The software cuts off the power to both motors of a PDU if the correct indication from limit switches is not received within the one motor operation time. Table 4.1.1 shows the times required to operate the PLBD and radiator panel systems on two motors and one motor, and the timing switch cutoff time (which is always equal to the one motor drive time).

Table 4.1.1:

PLBD and Radiator Panel Mechanisms' Operating Times

Mechanical System	Time (seconds)		
	Dual Motor	Single Motor	Power Cut-off
Centerline Latches (4 gangs)	20	40	40
Bulkhead Latches (4 gangs)	30	60	60
PLBD Drive (each door)	63	126	126
Radiator Panel Latches (4 gangs)	26	52	52
Radiator Panel Drive (each side)	43	86	86

4.2 EVA ACTIVITIES

Each PLBD (Payload Bay Door) and radiator panel mechanism incorporates a stowage, closure capability by Extravehicular Activity (EVA) into its design. This is to insure the safe return of the crew and the orbiter under the conditions of a mechanical failure. The PLBDs and radiator panels do not provide structural support for the orbiter at any time, however, the PLBDs must be closed during reentry to provide an aerodynamic fairing between the forward and aft fuselages.

EVA capability is built into the stowage of the deployable radiator panels, but not in their deployment. If the forward radiator panels are required to be deployed for a mission and can not be deployed, quick trouble shooting can be used to correct the situation, but there is not enough time for EVA. In this case, the mission would be sacrificed and the orbiter would return to earth after only a few orbits because heat rejection capabilities would be insufficient for mission requirements.

EVA activity is complex. Mechanical failures in the PLBD and radiator panel systems, which require EVA, involve many different operations and tools. Further information on EVA can be found in the EVA Contingency Operations Training Workbook.

Bibliography

The following sources were used for reference for this handbook:

Rockwell's Space Shuttle Transportation System Press Guide
NASA's Space Shuttle Transportation System Press Guide
Lockheed's Orbiter Vehicle Structures Manual
Vought's Radiator Repair Manual
NASA/JSC's Mechanical Systems Training Manual
NASA/JSC's EVA Contingency Operations Training Workbook
NASA/KSC's Environmental Control and Life Support Systems
(ECLSS) Handbook
NASA/KSC's 1990 Annual Report on Research and Technology (NASA
Technical Memorandum 103811)
SAE International Technical Paper Series, Number 911366 (Shuttle
Active Thermal Control Subsystem Design and Flight Experience
Lockheed's Mechanical System Training Manual
Payload Bay Door Mechanism - Subsystem, Mechanical and EPD&C
FMEA/CIL Review
Numerous Rockwell Drawings